



# Table of Contents

Machine / Model	Pages
GTO 46 / 52	1 - 17
KOR, KORA, KORD 62 / 64, KORS	18 - 28
M-SERIES	29 - 31
QUICKMASTER 46 / 46DI	32 - 34
SPEEDMASTER 52 / 72 / 102	35 - 41
SB, SORDZ, SORKZ, SORM, SORZ	42 - 47
TOK, TOM	48 - 49
WINDMILL 10 x 15 / 13 x 18	50 - 52
SHEET SEPARATORS	53
GRIPPER FINGERS	54
SUCKER FEET, SUCKER BAR SLIDES, FILTERS	55
BELTS, LIMIT SWITCHES	56
ELECTRICAL, CARBON BRUSHES, REPAIR KITS	57 - 58
CAM FOLLOWERS	58 - 59
CYLINDER JACKETS, WASH UP BLADES	59
INK FOUNTAIN BLADES	60
ROLLER KITS	61
BLANKETS	62
TOOLS	63

# REPLACEMENT PARTS FOR HEIDELBERG GTO 46/52

## - FEEDER SECTION -



**SHEET SEPARATORS** - For GTO 52 Stream feed  
(SEE PAGE #54 FOR OTHER SHEET SEPARATORS)

Operators side (shown) . . . . . HE-52106  
Non-operators side. . . . . HE-52107

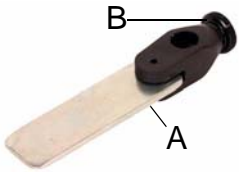

**HOLDER ASSEMBLY - WINDMILL PLATENS**

(also used on GTO 46 / 52)

COMPLETE . . . . . HE-WI434

(A) Replacement roll pin . . . . . P-2839

(B) Replacement thumb screw . . . . . P-2022



**SHEET STEADIER ASSEMBLY - GTO 46 / 52**

(also used on K-Series & 3Windmill)

COMPLETE . . . . . HE-KØØ27

(A) Sheet steadier . . . . . HE-KØR090

(B) Holder . . . . . HE-46049

(C) Thumb screw . . . . . P-2022

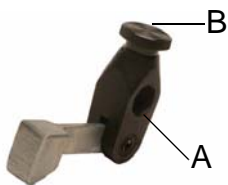

**HOLDER ASSEMBLY - GTO 46 / 52**

(also used on K-Series & Windmill)

COMPLETE . . . . . HE-KØ625

(A) Replacement roll pin . . . . . P-2839

(B) Replacement thumb screw . . . . . P-2022



**SPRING** - GTO 46 / 52 - For feed jogger lever.

(also used on Speedmaster 102)

HE-46392



**THREADED BUSHING** - GTO 46 / 52 - On feed table bracket.

(also used on K-Series)

Same for O.S. and D.S.

HE-46970



**HANDLE** - GTO 46 / 52 - For sheet stop.

Same for O.S. and D.S.

(also used on Windmill Platens)

P-7224



(A) **SLIP RING CARBON BRUSH** - GTO 52 . . . . . P-9417

(B) **COMMUTATOR CARBON BRUSH** - GTO 52 . . . . . P-9418

# REPLACEMENT PARTS FOR HEIDELBERG

## GTO 46/52

### FEED GRIPPER ASSEMBLY - GTO 46 / 52

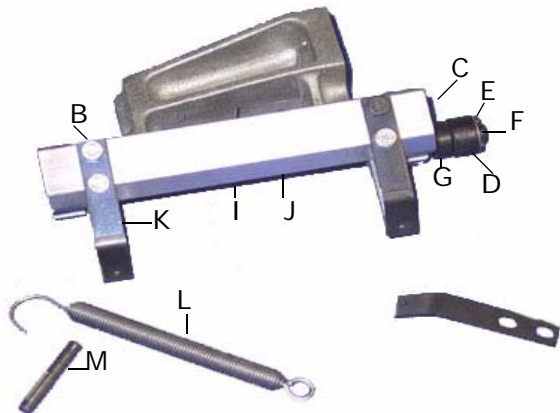

NOTE:  
Torsion spring "N" is no longer used. Spring "L"  
and grooved pin "M" are used in place of it.



**HE-46212  
GRIPPER FINGER**

<b>COMPLETE</b> . . . . .	HE-46511
(A) Gripper finger . . . . .	HE-46212
(B) Hex head screw . . . . .	P-2088
(C) Needle bearing. . . . .	P-3466
(D) Cam roller . . . . .	P-6838
(E) Flat washer . . . . .	P-595
(F) E-ring . . . . .	P-2759
(G) Stud-for cam roller. . . . .	P-7943
(H) Taper pin. . . . .	P-431
(I) Connecting piece (not shown) . . . . .	P-11923
(J) Torsion spring . . . . .	HE-46212-T
(K) Backing Plate. . . . .	HE-46212-BP
(L) Spring. . . . .	HE-46212-E
(M) Grooved pin. . . . .	P-3037



**HOSE** - GTO 46 / 52 - Connects to blower tube bar from air pump on feeder.

P-5299



**HOSE CLAMP** - GTO 46 / 52 - For hose #P-5299.

P-1160



**BOLT** - GTO 46 / 52 - On end of side lay shaft (gear side).

P-4786

**CAM ROLLER** - Operates with #P-4786 bolt

P-4368



**THREADED STUD** - GTO 46 / 52 - For side guide lever.

P-9128

**WING NUT** - GTO 46 / 52 - For side guide lever.

P-3399

# REPLACEMENT PARTS FOR HEIDELBERG GTO 46/52



## SHEET STEADIER BRUSH - GTO 46 / 52

(also used on K-Series)

Complete . . . . .	HE-46403
(A) Brush only . . . . .	HE-46420
(B) Wing nut . . . . .	P-3399
(C) Shoulder screw . . . . .	P-8176

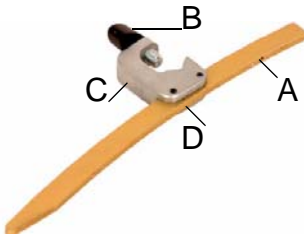

## SHEET SMOOTHER - GTO 46 (Short)

Complete . . . . .	HE-46352
(A) Bar only . . . . .	Not Sold Alone
(B) Thumb screw . . . . .	P-2924
(C) Block only . . . . .	HE-KØR359
(D) Roll pin . . . . .	P-516

\*\* bars (A) alone have no holes and need to be drilled per your block.

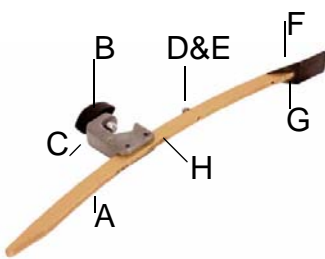

## SHEET SMOOTHER - GTO 46 (Long)

Complete . . . . .	HE-46434
(A) Bar only . . . . .	HE-46483
(B) Thumb screw . . . . .	P-2924
(C) Block only . . . . .	HE-KØR359
(D) Screw . . . . .	P-2305
(E) Nut . . . . .	P-2600
(F) Pan head screw . . . . .	P-2355
(G) Plate spring . . . . .	HE-46779
(H) Roll pin . . . . .	P-516

\*\* bars (A) alone have no holes and need to be drilled per your block.

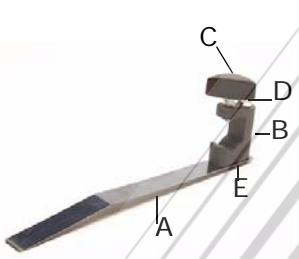

## SHEET BRAKE - GTO 46 / 52

(also used on K-Series & SB-Series)

COMPLETE . . . . .	HE-52467
(A) Strap only . . . . .	HE-52500
(B) Block only . . . . .	HE-52473
(C) Thumb screw . . . . .	P-2924
(D) Stop nut . . . . .	P-2610
(E) Screw . . . . .	P-8174

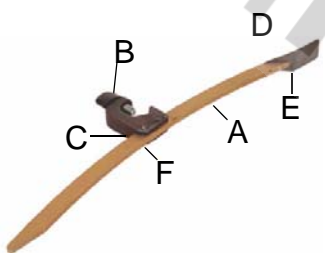

## SHEET SMOOTHER - GTO 52

Complete . . . . .	HE-52434
(A) Bar only . . . . .	HE-52483
(B) Thumb screw . . . . .	P-2924
(C) Block only . . . . .	HE-KØR359
(D) Pan head screw . . . . .	P-2355
(E) Plate spring . . . . .	HE-46779
(F) Roll pin . . . . .	P-516

\*\* bars (A) alone have no holes and need to be drilled per your block.

# REPLACEMENT PARTS FOR HEIDELBERG GTO 46/52



**Side Lay Lever - GTO 46/52**

HE-52096



**Handle - Revolving knob for GTO 46**

P-7222

## - CYLINDER SECTION -



**CAM FOLLOWER - GTO 46 / 52 -**

Located on outside of D.S. transfer gripper roller lever.  
(see page #59 for other cam followers)

P-3441



**TRANSFER GRIPPER - GTO 46 / 52 - Transfer & impression cyl.'s**  
(also used on M-Series)

(with urethane) . . . . . HE-52245  
(without urethane) . . . . . HE-52237



**COMPRESSION SPRING - GTO 45 / 52**

For clamping piece on transfer gripper.

P-15843



**SPRING - GTO 46 / 52 - For rod on numbering unit.**

HE-46517



**FRONT GUIDE - GTO 46 / 52**

Located on transfer gripper between gripper feet.  
(also used on K-Series)

(A) FRONT GUIDE ONLY . . . . . HE-K0383  
(B) ADJUSTING KNOB . . . . . P-2932  
(C) RETAINER SPRING . . . . . HE-K0257  
(D) ADJUSTING SCREW . . . . . P-2912

# REPLACEMENT PARTS FOR HEIDELBERG GTO 46/52



**SPRING** - GTO 52  
For gripper operating cam on reversing drum.

HE-52379

**A**

**B**

**REVERSING DRUM GRIPPER** - GTO 52

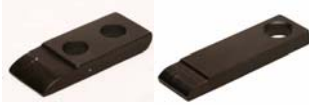

(A) UPPER POSITION. . . . . HE-521020-RU

(B) LOWER POSITION . . . . . HE-521020-RL



**SPRING** - GTO 52 - For gripper holder.

(12 mm X 4.5 mm). . . . . HE-52843



**CLAW** - GTO 46 / 52 - For blanket & impression cyl. clamp shaft.  
(also used on M-Series)

HE-46390

**BLANKET BAR ASSEMBLY** - GTO 46 / 52

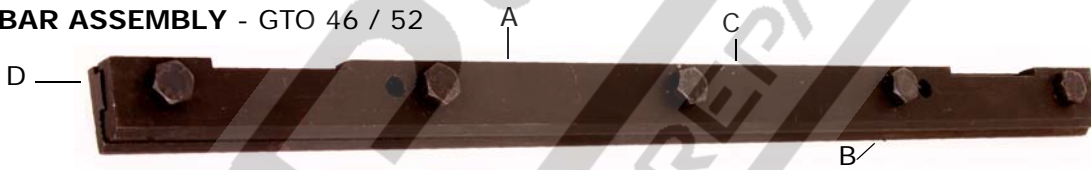

**COMPLETE** - GTO 46 . . . . . HE-46252

**COMPLETE** - GTO 52 . . . . . HE-52252

- (A) Upper clamp - 46 . . . . . HE-46258
- (A) Upper clamp - 52 . . . . . HE-52258
- (B) Lower clamp - 46 . . . . . HE-46256
- (B) Lower clamp - 52 . . . . . HE-52256
- (C) Spring - 46 / 52 . . . . . P-12319
- (D) Screw - 46 / 52 . . . . . P-2010

**A**



(A) **THRUST BEARING** - GTO 46 / 52 - For Blanket cyl. O.S.

P-3429

**B**



(B) **AXIAL BEARING WASHER** - GTO 46 / 52 - For #P-3429 Bearing.

P-2744



# REPLACEMENT PARTS FOR HEIDELBERG GTO 46/52

## PLATE CLAMP ASSEMBLY - LEAD EDGE - GTO 46



**COMPLETE** . . . . . HE-46788

- (A) Upper clamp . . . . . HE-46359
- (B) Eccentric shaft . . . . . HE-46435
- (C) Thumb screw . . . . . P-2917
- (D) Spring . . . . . HE-46896
- (E) Screw . . . . . P-2101
- (F) Washer . . . . . P-5519
- (G) Adjusting bracket . . . . . HE-46755
- (H) Lower clamp . . . . . HE-46353
- (I) Spring . . . . . P-12909
- (J) Screw . . . . . P-2418
- (K) Metal strip . . . . . HE-46353-M
- (L) Set screw (not shown) . . . . . P-2508

## PLATE CLAMP ASSEMBLY - GTO 46 - For BACHER PLATE

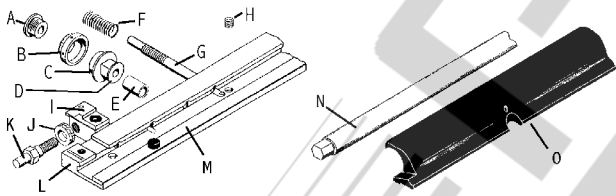

**Complete** . . . . . HE-46788-BC

- (A) Collar . . . . . P-6725
- (B) Collar scale . . . . . P-6726
- (C) Adjustment holder . . . . . HE-52351
- (D) Washer . . . . . P-2749
- (E) Spacer . . . . . P-6802
- (F) Spring . . . . . P-12148
- (G) Threaded stud . . . . . P-9137
- (H) Spring . . . . . P-12909
- (I) Adjusting block . . . . . HE-52755
- (J) Ring scale . . . . . P-6724
- (K) Adjusting stud . . . . . P-7199
- (L) Lower clamp . . . . . HE-46353-BC
- (M) Metal strip . . . . . HE-46353-M
- (N) Eccentric shaft (2 per assm) . . . . . HE-46435
- (O) Upper clamp (1 per assm) . . . . . HE-46359



# REPLACEMENT PARTS FOR HEIDELBERG GTO 46/52

## PLATE CLAMP ASSEMBLY - TAIL EDGE - GTO 46 / 52

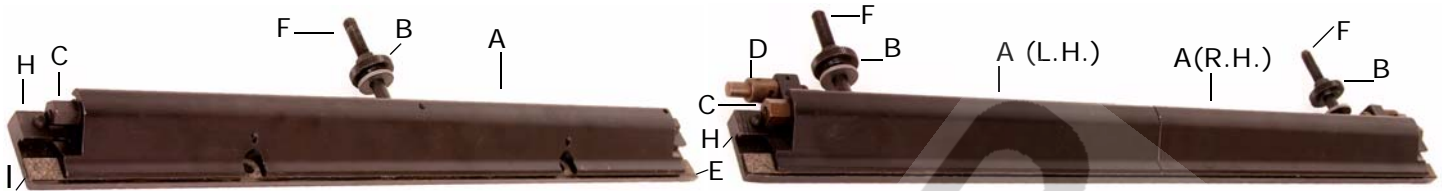

<b>GTO 46 Complete</b> . . . . .	HE-46367
<b>GTO 52 Complete</b> . . . . .	HE-52367
(A) Upper clamp - GTO 46 . . . . .	HE-46359
(A) Upper clamp - GTO 52 (L.H.) . . . . .	HE-52359-L
(A) Upper clamp - GTO 52 (R.H.) . . . . .	HE-52359-R
(B) Knurled adjusting nut . . . . .	P-2949
(C) Eccentric shaft - GTO 46 . . . . .	HE-46435
(C) Eccentric shaft - GTO 52 . . . . .	HE-52435
(D) Adjusting stud . . . . .	P-7198
(E) Lower clamp - GTO 46 . . . . .	HE-46353
(E) Lower clamp - GTO 52 . . . . .	HE-52353
(F) Threaded stud . . . . .	P-9138
(G) Spring (not shown) . . . . .	P-12909
(H) Screw . . . . .	P-2418
(I) Metal strip - GTO 46 . . . . .	HE-46353-M
(I) Metal strip - GTO 52 . . . . .	HE-52353-M
(J) Set screw . . . . .	P-2508

## PLATE CLAMP ASSEMBLY - For BACHER PLATE - GTO 46



<b>GTO 46 Complete</b> . . . . .	HE-46367-BC
(A) Upper clamp - (L.H.) . . . . .	HE-46359-L
(B) Upper clamp - (R.H.) . . . . .	HE-46359-R
(C) Knurled adjusting nut . . . . .	P-2949
(D) Flat washer . . . . .	P-10942
(E) Eccentric shaft . . . . .	HE-46435
(F) Adjusting stud . . . . .	P-7198
(G) Lower clamp sub assembly (includes I & J) . . . . .	HE-46353-BC-S
(H) Lower clamp only . . . . .	HE-46353-BC
(I) Rubber strip . . . . .	HE-46353-R
(J) Metal strip . . . . .	HE-46353-M
(K) Threaded stud . . . . .	P-9138
(L) Spring . . . . .	P-12909
(M) Screw . . . . .	P-2418

# REPLACEMENT PARTS FOR HEIDELBERG GTO 46/52

## PLATE CLAMP ASSEMBLY- LEAD EDGE - GTO 52

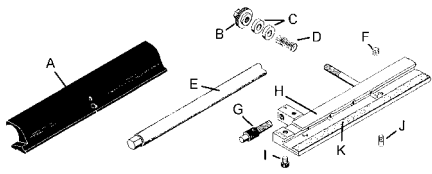

<b>COMPLETE</b> . . . . .	HE-52788
(A) Clamp . . . . .	HE-52359
(B) Knurled adjusting nut . . . . .	P-2949
(C) Spacer . . . . .	P-6843
(D) Spring . . . . .	P-12148
(E) Eccentric shaft . . . . .	HE-52435
(F) Spring . . . . .	P-12909
(G) Adjusting stud . . . . .	P-7198
(H) Lower clamp . . . . .	HE-52353
(I) Screw . . . . .	P-2418
(J) Set screw . . . . .	P-2508
(K) Metal strip . . . . .	HE-52353-M

## PLATE CLAMP ASSEMBLY - GTO 52 -For BACHER PLATE

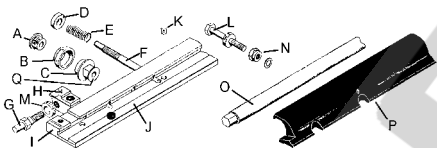

<b>Complete</b> . . . . .	HE-52788-BC
(A) Collar . . . . .	P-6725
(B) Collar scale . . . . .	P-6726
(C) Adjustment holder . . . . .	HE-52351
(D) Spacer cam . . . . .	P-6843
(E) Spring . . . . .	P-12148
(F) Threaded stud . . . . .	P-9137
(G) Adjusting stud . . . . .	P-7199
(H) Adjusting block . . . . .	HE-52755
(I) Lower clamp . . . . .	HE-52353
(J) Metal strip . . . . .	HE-52353-M
(K) Spring . . . . .	P-12909
(L) Hex head screw . . . . .	P-2089
(M) Ring scale . . . . .	P-6724
(N) Nut . . . . .	P-2634
(O) Eccentric shaft (2 per assm) . . . . .	HE-52435
(P) Upper clamp (1 per assm) . . . . .	HE-52359
(Q) Washer . . . . .	P-2749

# REPLACEMENT PARTS FOR HEIDELBERG GTO 46/52

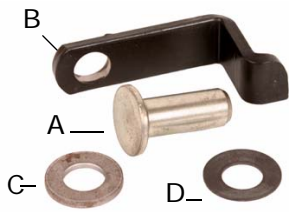

- (A) STUD** - GTO 46 / 52  
(this stud is also used on both upper and lower delivery rod heads)  
P-7168
- (B) SUPPORT BRACKET** - GTO 46 / 52 - For plate cylinder tail clamp  
HE-46391
- (C) WASHER**  
P-2732
- (D) CUP SPRING WASHER**  
P-11829



- THREADED BUSHING** - GTO 46 / 52 - For plate cylinder clamp assy  
HE-46329



- TRIP BLOCK** - GTO 52 - For plate clamp  
HE-52391



- Cam Lever** - GTO 52  
HE-52136



- Torsion Rod** - GTO 52  
(For Torsion Gripper)  
HE-52213-2



- Threaded Bolt** - GTO 52  
(for HE-52136)  
P-9134



- Eccentric Stud Kit** - GTO 52  
(for HE-52136)  
P-4544



- Sheet Guide** - GTO 46/52  
(also for K-Series)
- Drive Side . . . . . HE-K0R175-DS
- Operator's Side . . . . . HE-K0R175-OS

# REPLACEMENT PARTS FOR HEIDELBERG GTO 46/52

## - INK & WATER SECTION -

### ROLLER BEARING SLEEVES - GTO 46 / 52



Water oscillator (NOS) . . . . .	HE-52432
Water oscillator (OS) . . . . .	HE-52436
Upper steel oscillator (OS) . . . . .	HE-52476
Steel osc. - 2nd. from top. . . . .	HE-52496
Ink distributor (NOS) . . . . .	HE-52494
Ink osc./dist.- front & rear . . . . .	HE-52548

### INK UNIT OVER-RUNNING CLUTCH LEVER - GTO 46 / 52



**COMPLETE** . . . . . HE-46259

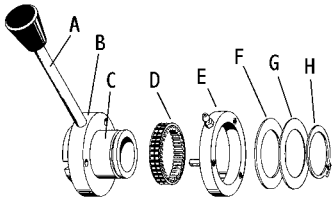

(A) Lever & knob assembly . . . . .	P-320416
(B) Collar - without pins . . . . .	P-6785
(C) Bearing race . . . . .	HE-46261
(D) One way clutch bearing . . . . .	P-3454
(E) Collar - with pins . . . . .	P-6784
(F) Bearing retainer . . . . .	P-2720
(G) Belleville washer . . . . .	P-11833
(H) Retaining ring . . . . .	P-10752

### INK & WATER OVER-RUNNING CLUTCH ASSY. - GTO 46/52



**COMPLETE (INK)** . . . . . HE-52226

**COMPLETE (WATER)** . . . . . HE-52370

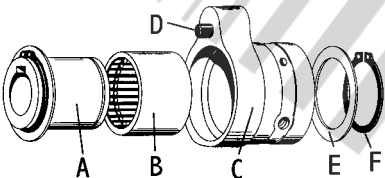

(A) Sleeve . . . . .	HE-52226-S
(B) One way clutch bearing . . . . .	P-3458
(C) Housing only . . . . .	Not Sold Alone
(D) Pin . . . . .	P-4792
(E) Washer . . . . .	P-2720
(F) Retaining ring . . . . .	P-10752

### INK DISTRIBUTOR GEAR - GTO 46 / 52



HE-52534

# REPLACEMENT PARTS FOR HEIDELBERG GTO 46/52

## INK FOUNTAIN BLADE



GTO 46 . . . . . HE-46095  
GTO 52 . . . . . HE-52095

## Segmented Ink Fountain Blade - GTO-52



HE-52095-S

## INK FOUNTAIN ADJUSTING SCREW - GTO 46 / 52

(A) For numbering unit . . . . . P-2021



**ADJUSTING SCREW** - GTO 46 / 52 - For ink fountain blade  
(also used on M-Series, Speedmaster 72)

(B) Standard ink unit . . . . . P-2928

## LOWER DAMPENING BEARING SUPPORT - GTO 46 / 52

**O.S. GREEN** - COMPLETE . . . . . HE-46400

**D.S. GREEN** - COMPLETE . . . . . HE-46415

(A) Spring (inside "B") . . . . . HE-46896

(B) Handle . . . . . P-7174

(C) Shoulder screw . . . . . P-8171

(D) Dowel pin . . . . . P-3132

(E) Trunnion stud . . . . . P-7173

(F) Set screw (to hold "G") . . . . . P-2501

(G) Eccentric stud . . . . . P-7163

(H) Grooved pin . . . . . P-2899

(I) Grooved pin . . . . . P-4780

(J) O-ring . . . . . P-5330

(K) Brass stud . . . . . P-7174

(L) Nut . . . . . P-2601

(M) Screw (for brass stud) . . . . . P-6530

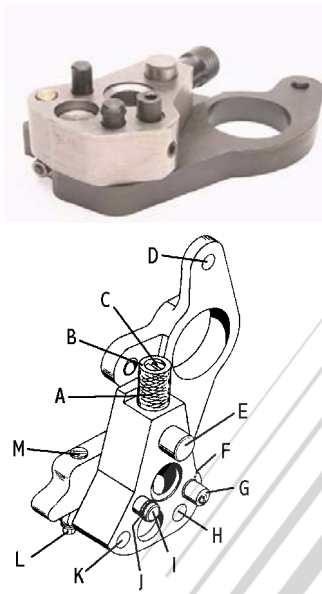

## TEFLON SEALS - GTO 46 / 52 - For use on Varn units.



Pack of 2 pcs. (1 set) . . . . . P-30712

Pack of 5 sets . . . . . P-31168

Pack of 10 sets . . . . . P-31169

## WATER CLUTCH ASSEMBLY - GTO 46 / 52



HE-46418



# REPLACEMENT PARTS FOR HEIDELBERG

## GTO 46/52

### WATER FOUNTAIN TRAYS - GTO 46



Old Style



New Style

GTO 46 Old style (ser. # 650058 to 654211) . . . . .	HE-46316-OS
GTO 46 New style ( ser. # 656798 to 698328) . . . . .	HE-46316-NS

### SPRINGS - GTO 46 / 52 - For spring rods.



(11.5 mm X 43.0 mm) . . . . .	HE-46413
(9 mm X 70 mm) . . . . .	HE-46519
(9.5 mm X 62 mm) . . . . .	HE-46798

### UPPER DAMPENING BEARING SUPPORT - GTO 46 / 52

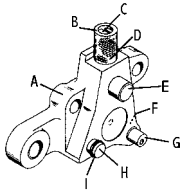

GTO 46 / 52 D.S. <b>COMPLETE</b> . . . . .	HE-46344
GTO 46 / 52 O.S. <b>COMPLETE</b> . . . . .	HE-46346
(A) Support only . . . . .	HE-46350
(B) Handle . . . . .	P-7214
(C) Shoulder screw . . . . .	P-8171
(D) Spring (inside "B") . . . . .	HE-46896
(E) Trunnion stud . . . . .	P-7173
(F) Set screw (to hold "G") . . . . .	P-2501
(G) Eccentric stud . . . . .	P-7163
(H) Grooved pin . . . . .	P-4780
( I ) O-ring . . . . .	P-5330

### BEARING SUPPORT - GTO 46 / 52

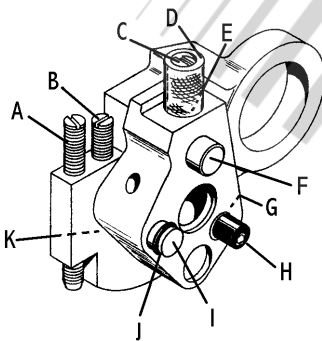

GTO 46 D.S. - RED , O.S. - YELLOW / GTO 52 D.S. - RED	
<b>COMPLETE</b> (w/o latch) . . . . .	HE-46558
GTO 52 O.S. - YELLOW	
<b>COMPLETE</b> (with latch) . . . . .	HE-52558
GTO 46 / 52 D.S. - YELLOW / O.S. - RED	
<b>COMPLETE</b> (w/o latch) . . . . .	HE-46614
(A) Set screw . . . . .	Not Sold Alone
(B) Set screw . . . . .	P-2538
(C) Shoulder screw . . . . .	P-8171
(D) Handle . . . . .	P-7214
(E) Spring (inside "D") . . . . .	Not Sold Alone
(F) Trunnion stud . . . . .	P-7173
(G) Set screw (to hold "H") . . . . .	P-2501
(H) Eccentric stud . . . . .	P-7163
(I) Grooved pin . . . . .	P-4780
(J) O-ring . . . . .	P-5330
(K) Spring (underneath "B") . . . . .	P-152422
(L) Latch (for HE-52558) . . . . .	HE-46590

# REPLACEMENT PARTS FOR HEIDELBERG GTO 46/52



**BEARING SUPPORT - GTO 46 / 52**  
GTO 46 / 52 D.S.WHITE / O.S. BLUE

**COMPLETE . . . . . HE-46584**

**GTO 46 D.S. BLUE- COMPLETE . . . . HE-46586**

**GTO 52 O.S. WHITE- COMPLETE . . . HE-52586**

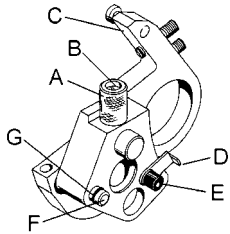

- (A) Handle . . . . . P-7214
- (B) Shoulder screw . . . . . P-8171
- (C) Bracket assembly . . . . . HE-46618
- (D) Eccentric stud . . . . . P-7163
- (E) Bearing support . . . . . HE-46611
- (F) Grooved pin . . . . . P-4780
- (G) O-Ring . . . . . P-5330



**Washup Tray Assembly**

GTO 52 . . . . . HE-52773  
GTO 46 . . . . . HE-46773

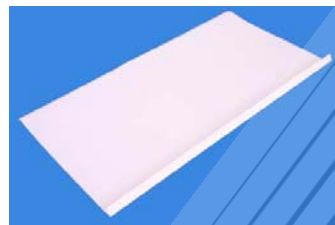

**Ink Fountain Liner - Box of 100**

GTO-52, SM-52 . . . . . P-29993  
SM-102 . . . . . P-29994  
SM-72, SM-74 . . . . . P-29995  
MO . . . . . P-29996  
QM46 . . . . . P-29997



**Form Roll Separator Handle - GTO 46/52**

P-27407



**Ink Fountain Knob - GTO 46/52**  
(also on Speedmaster 72 and S Series)

P-2910



# REPLACEMENT PARTS FOR HEIDELBERG GTO 46/52

## - DELIVERY SECTION -



**GRIPPER CHAINS** - GTO 46 / 52 Sold as a set

HE-521100

### STAR ROD ASSEMBLIES



GTO 46 Complete with spring . . . . . HE-463170  
 GTO 52 Complete with spring . . . . . HE-523170  
 Spring only (for both) . . . . . HE-463110

### GRIPPER BAR ASSEMBLY - GTO 46 / 52

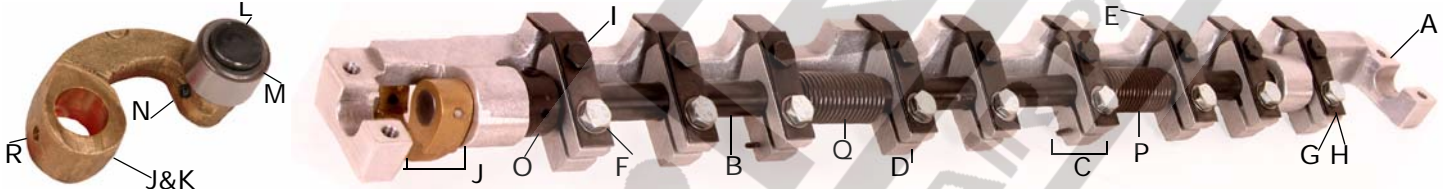

**COMPLETE** (GTO 46) . . . . . HE-460990  
**COMPLETE** (GTO 52) . . . . . HE-520990

- (A) Anvil (GTO 46) . . . . . HE-461090
- Anvil (GTO 52) . . . . . HE-521090
- (B) Shaft (GTO 46) . . . . . HE-461060
- Shaft (GTO 52) . . . . . HE-521060
- (C) \*Holder assembly . . . . . HE-521000
- (D) \*\*Holder . . . . . HE-521061
- (E) \*\*Finger with urethane . . . . . HE-521020
- (F) \*\*Backing plate. . . . . HE-521062
- (G) \*\*Holding screw . . . . . P-2003
- (H) \*\*Belleville washer . . . . . P-651
- (I) \*\*Shoulder screw . . . . . P-8161
- (J) \*Arm assembly . . . . . HE-521040
- (K) \*\*Arm only . . . . . HE-521041
- (L) \*\*Cam roller stud . . . . . P-7159
- (M) \*\*Cam roller . . . . . P-11179
- (N) \*\*Pin . . . . . P-373
- (O) Collar . . . . . P-6739
- (P) Spring . . . . . HE-521080
- (Q) Spring . . . . . HE-521085
- (R) Pin . . . . . P-2834

\*indicates a sub-assembly.

\*\*indicates components of a sub-assembly.

Note: Item (B) Shaft must be taper reamed for pins in field.



**STUD** - GTO 46 / 52 - Same for both upper and lower delivery rod head. (This stud is also used on plate cylinder tail clamp).

P-7168

# REPLACEMENT PARTS FOR HEIDELBERG GTO 46/52

## POWDER TUBE ASSEMBLY - GTO 46 / 52

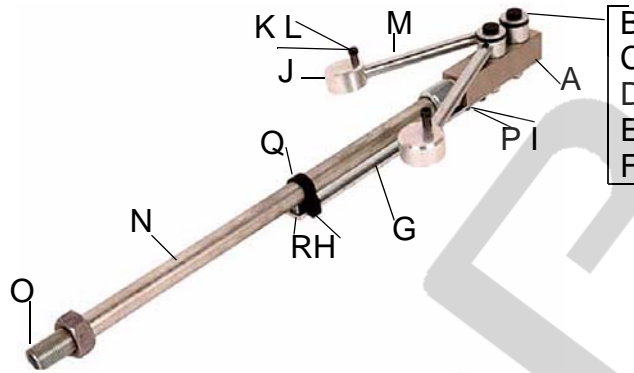

**COMPLETE - Short tube (A - R)** ..... HE-KØR6030  
**COMPLETE - Long tube (A - R)** ..... HE-KØR6040

**Powder tube sub assembly (A - M)** ..... HE-KØR6046  
 (A) Manifold ..... HE-KØR6050  
 (B) Screw ..... P-2044  
 (C) Washer ..... P-592  
 (D) Gasket ..... P-6422  
 (E) Rubber washer ..... P-11036  
 (F) Lock nut ..... P-2616  
 (G) Powder tube guide ..... HE-KØR6051  
 (H) Stop screw ..... P-2351  
 (I) Screw ..... P-2082

**Spray nozzle sub assembly (J - M)** ..... HE-KØR6047  
 (J) Nozzle - 3 Holes ..... HE-KØR6056  
 (J) Nozzle - 8 Holes ..... HE-466056  
 (K) Screw ..... P-2921  
 (L) Spring ..... P-15601  
 (M) Nozzle tube ..... HE-KØR6055

**Powder tube sub assembly - Short (N - R)** ..... HE-KØR6035  
**Powder tube sub assembly - Long (N - R)** ..... HE-KØR6045  
 (N) Short tube (for HE-KØR6030) ..... HE-KØR6052  
 (N) Long tube (for HE-KØR6040) ..... HE-KØR6053  
 (O) Nut ..... P-2681  
 (P) Compression nut with gasket ..... P-2941  
 (Q) Guide collar ..... HE-KØR6054  
 (R) Set screw ..... P-2499



## PAPER STRIPPER ANGLE BRACKET - GTO 46 / 52

HE-462301

# REPLACEMENT PARTS FOR HEIDELBERG GTO 46/52



**GUIDE STRAP - GTO 46 / 52**

HE-462281

**ROLLER KITS**

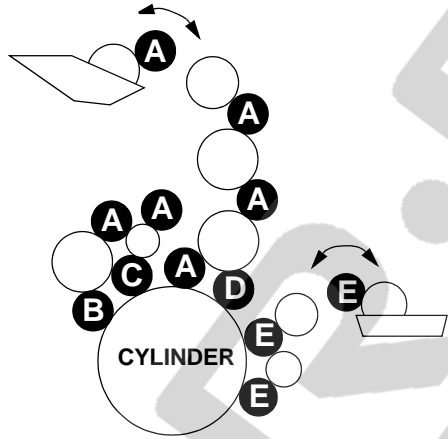

**GTO 46**

INK ROLLER KIT . . . . . P-30457

Consists of:

- (6) Blue Distributor / Ductor - [ A ] . . . . . P-46H10B
- (1) Red Form - [ B ] . . . . . P-46H10R
- (1) White Form - [ C ] . . . . . P-46H10W
- (1) Yellow Form - [ D ] . . . . . P-46H10Y

**GTO 46**

WATER ROLLER KIT . . . . . P-30458

Consists of:

- (3) Green Form / Ductor - [ E ] . . . . . P-46H10G

**GTO 52**

INK ROLLER KIT . . . . . P-30459

Consists of:

- (5) Blue Distributor / Ductor - [ A ] . . . . . P-52H10B
- (1) Red Form - [ B ] . . . . . P-52H10R
- (1) White Form - [ C ] . . . . . P-52H10W
- (1) Yellow Form - [ D ] . . . . . P-52H10Y

**GTO 52**

WATER ROLLER KIT (conventional) . . . . . P-30460

Consists of:

- (3) Green Form / Ductor - [ E ] . . . . . P-52H10G

HEIDELBERG IS A REGISTERED TRADEMARK OF HEIDELBERG-DRUCKMASCHINEN, AG

# REPLACEMENT PARTS FOR HEIDELBERG GTO 46/52

---



**Support Bar** - with Needle Bearings  
(for GTO 52)

HE-52846

---



**Star Wheel** - Knurled/Dimpled Surface  
(for GTO 46/52 and Speedmaster 52)

P-30842-GTO

---



**Perforated Wheel** - GTO 46/52  
(also for M series, Speedmaster 52/74)

P-31081

**Slitter Wheel** - GTO 46/52  
(not shown)

P-31082

---



**Timing Belt** - Suction Drum  
(for GTO 52)

P-3806

---



**Flexible Arm Shaft Assembly** - GTO, GTOZ/P

P-6202

**Collar Only**

P-6743

**Shaft only**

P-6203

---



**Hose** - GTO 46/52

28 inches (hose to feed gripper) . . . . . P-5260

55 inches (air pump to powder spray) . . . . . P-5288

---

# REPLACEMENT PARTS FOR HEIDELBERG K-SERIES

## - FEEDER SECTION -



**SHEET SEPARATOR HOLDER - KOR**

HE-KØR113

**SHEET SEPARATOR HOLDER - KORA, KORD, KORS**  
L.H. & R.H. HE-KØRD113

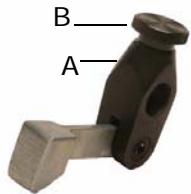

**HOLDER ASSEMBLY - K-Series**

(also used on GTO 46 / 52 & Windmill platens)

COMPLETE . . . . . HE-KØ625

(A) Replacement roll pin . . . . . P-2839

(B) Replacement thumb screw . . . . . P-2022



**HOLDER ASSEMBLY - K-Series - Sheet steadier support**  
(also used on GTO 46 / 52 & Windmills)

HE-KØR090

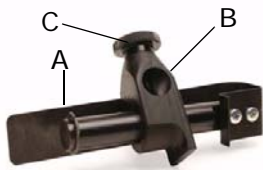

**SHEET STEADIER ASSEMBLY - GTO 46 / 52**

(also used on K-Series & 3 Windmill)

COMPLETE . . . . . HE-KØØ27

(A) Sheet steadier . . . . . HE-KØR090

(B) Holder . . . . . HE-46049

(C) Thumb screw . . . . . P-2022



**GUIDE PIECE - K-Series - Sheet steadier holder.**

HE- KSØ89



**SPRING GUIDE (tongue) - K-Series - For conveyor**

HE-KØR420

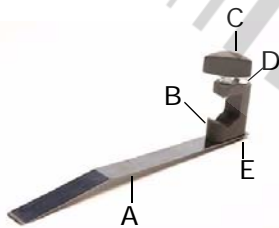

**SHEET BRAKE - K-Series**

(also used on GTO 46 / 52 & SB-Series)

COMPLETE . . . . . HE-52467

(A) Strap only . . . . . HE-52500

(B) Block only . . . . . HE-52473

(C) Thumb screw . . . . . P-2924

(D) Stop nut . . . . . P-2610

(E) Screw . . . . . P-8174



**RUBBER SLEEVE - K-Series - For table height control bar.**

P-8303

# REPLACEMENT PARTS FOR HEIDELBERG K-SERIES



**BEARING STUD** - K-Series - For table height control lever.

Ball bearing for #P-7164

P-7164

P-838



**THREADED BUSHING** - K-Series - On feed table bracket.

(also used on GTO 46 / 52)

Same for O.S. and D.S.

HE-46970

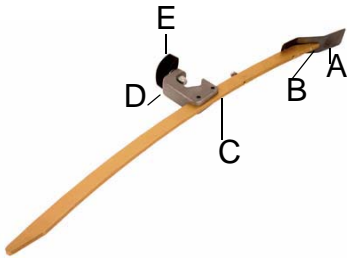

**SHEET SMOOTHERS** - KOR / KORA / KORD / KORS

**KOR COMPLETE** . . . . . HE-KØR434

**KORD/KORA COMPLETE** . . . . . HE-KØRD434

**KORS COMPLETE** . . . . . HE-KØRS434

(A) Spring plate (smoother) . . . . . HE-KØ779

(B) Screw . . . . . P-2355

(C) Bar only (KOR) \*\* . . . . . HE-KØR483

(C) Bar only (KORD/KORA) \*\* . . . . . HE-KØRD483

(C) Bar only (KORS) \*\* . . . . . HE-KØRS483

(D) Block . . . . . HE-KØR359

(E) Thumb screw . . . . . P-2924

\*\* bars (A) alone have no holes and need to be drilled per your existing block.

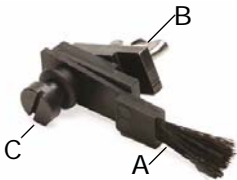

**SHEET STEADIER BRUSH** - K-Series

(also used on GTO 46 / 52)

Complete . . . . . HE-46403

(A) Brush only . . . . . HE-46420

(B) Wing nut . . . . . P-3399

(C) Shoulder screw. . . . . P-8176

## - CYLINDER SECTION -

### CYLINDER BRUSHES



KOR, KORA, KORD-62 . . . . . P-7659

KORD-64 . . . . . P-7657

KORS . . . . . P-7658

**IMPRESSION CYLINDER GRIPPER FINGER** - KORD 64

(SEE PAGE #46 FOR ALL OTHER GRIPPER FINGERS)

HE-KØR225



SCREW - For gripper finger

P-2086



**K-SERIES**

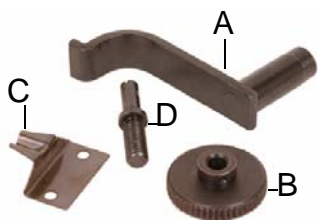

**FRONT GUIDE - K-Series**

Located on transfer gripper between gripper feet.  
(also used on GTO 46 / 52)

- (A) FRONT GUIDE ONLY . . . . . HE-K0383
- (B) ADJUSTING KNOB . . . . . P-2932
- (C) RETAINER SPRING . . . . . HE-KØ257
- (D) ADJUSTING SCREW . . . . . P-2912

**BLANKET BAR ASSEMBLY**



- COMPLETE (**KOR**) . . . . . HE-KØR252
- COMPLETE (**KORD**) . . . . . HE-KØRD252
- COMPLETE (**KORS**) . . . . . HE-KØRS252
- (A) Upper clamp (**KOR**) . . . . . HE-KØR258
- (A) Upper clamp (**KORD**) . . . . . HE-KØRD258
- (A) Upper clamp (**KORS**) . . . . . HE-KØRS258
- (B) Lower clamp (**KOR**) . . . . . HE-KØR256
- (B) Lower clamp (**KORD**) . . . . . HE-KØRD256
- (B) Lower clamp (**KORS**) . . . . . HE-KØRS256
- (C) Spring (**All models**) (not shown) . . . . . P-12319
- (D) Screw (**All models**) . . . . . P-2009

**PLATE CLAMP ASSEMBLY**



- COMPLETE (K-Series) . . . . . HE-KØRD367
- (A) Screw (4 per clamp) . . . . . P-2008
- (B) Upper clamp . . . . . HE-KØRD359
- (C) Washer . . . . . P-10942
- (D) Spring (4 per clamp) (not shown) . . . . . P-12319
- (E) Lower clamp . . . . . HE-KØRD353
- (F) Screw . . . . . P-2105
- (G) Lockwasher (not shown) . . . . . P-5519
- (H) Block assembly . . . . . HE-KØR755
- (I) Nut . . . . . P-2604
- (J) Screw . . . . . P-2510



**Shoulder Screw**  
(also for SB series)

P-8178



# REPLACEMENT PARTS FOR HEIDELBERG K-SERIES

## - INK & WATER SECTION -



**INK BLADE ADJUSTING SCREWS**  
(also used on Windmills)

P-2929

### INK DISTRIBUTOR ADJUSTING BLOCKS - K-Series

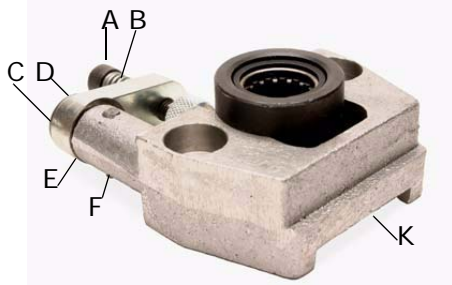

**Operators Side**



**Drive Side**

**Drive side** (complete) . . . . . HE-KØR494K-DS  
(consists of (A) through (K))

**Operators side** (complete) . . . . . HE-KØR494K-ØS  
(consists of (A) through (K))

**BEARING LATCH ASSY.** items (A) thru (F). - HE-KØR494-LA

- (A) Screw-Cone point . . . . . P-2132
- (B) Spring . . . . . HE-46896
- (C) Latch . . . . . HE-KØR494-L
- (D) Stud . . . . . P-7164
- (E) Spring washer . . . . . P-11826
- (F) Taper pin . . . . . P-431

**JOURNAL BOX ASSY.** (items (B) & (G) thru (J). - HE-KØR494-JBC

- (B) Spring . . . . . HE-46896
- (G) Journal box . . . . . HE-KØR494-JB
- (H) Retaining ring . . . . . P-2771
- (I) Needle bearing . . . . . P-2117
- (J) Adjusting screw . . . . . P-2913
- (K) Block only (drive side) . . . . . HE-KØR494-DS
- (K) Block only (operators side) . . . . . HE-KØR494-OS

### INK FOUNTAIN BLADES



- KOR . . . . . HE-KØR095
- KORS . . . . . HE-KØRS095
- KORD 64 . . . . . HE-KØRD095

# REPLACEMENT PARTS FOR HEIDELBERG K-SERIES

## INK UNIT OVER-RUNNING CLUTCH ASSEMBLY - K-Series

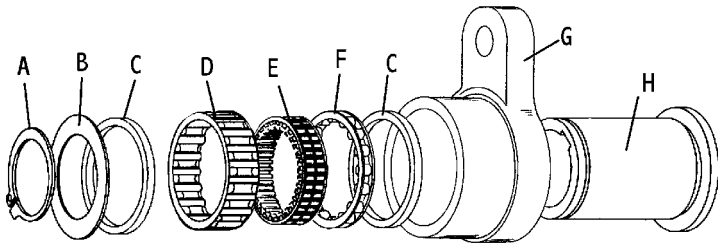

**Complete** ..... HE-KØ370

- (A) Retaining ring ..... P-2778
- (B) Flat washer ..... P-2715
- (C) Ring washer ..... P-2716
- (D) Bearing cage ..... P-3452
- (E) One-way clutch bearing ..... P-3447
- (F) Bearing cage ..... P-3448
- (G) Housing ..... Not Sold Alone
- (H) Sleeve ..... HE-KØ370-S

## INK BACK UP / FEED COLLAR ASSEMBLY - K-Series



- COMPLETE** ..... HE-KØ538
- (A) Collar - w / (B & D) ..... HE-KØ355
- (B) Bearing ..... P-3460
- (C) Spring ..... P-362130
- (D) Roll pin ..... P-10452
- (E) Cam roller ..... P-6838
- (F) Stud ..... P-7169

## WATER FOUNTAIN END SUPPORT -All K-Series

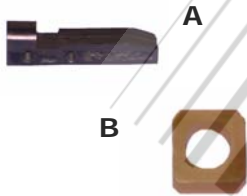

- (A) HE-KØR10102

## PLASTIC WATER FOUNTAIN ROLLER BEARING - K Series

- (B) HE-KØR10104



## BRAKE - K-series - For water fountain roller.

HE-KØ453



## SPRING - All K-Series

Located inside of cap on the outside of water ductor roller - D/S.

HE-KØ408

# REPLACEMENT PARTS FOR HEIDELBERG K-SERIES



**ADJUSTING GEAR** - K-Series - For water distributor roller.

HE-KØRD516



**WATER FOUNTAIN HOSE CLAMP** - All K-Series

CLAMP . . . . . HE-KØR347

SCREW . . . . . P-2022

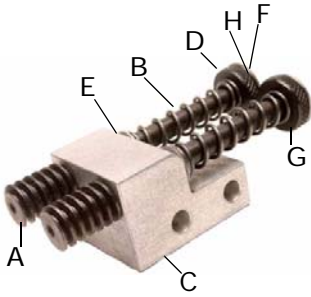

**DAMPENING ROLLER ADJUSTMENT BLOCK** - All K-Series

**COMPLETE** . . . . . HE-KØR416

(A) Gear shaft . . . . . HE-KØR304

(B) Spring . . . . . HE-KØR328

(C) Bracket . . . . . HE-KØR418

(D) Knurled nut . . . . . P-2946

(E) E-ring . . . . . P-2754

(F) Decal washer . . . . . P-7464

(G) Decal washer . . . . . P-7465

(H) Nut . . . . . P-2603

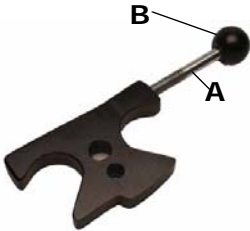

**SELECTOR SAFETY LEVER** - All K-Series

**Complete** . . . . . HE-KØR688

(A) Handle . . . . . P-9138

(B) Knob . . . . . P-11540



**Ductor & Form Cover** - KØRD 64

P-30134



**Clean Up Hose** - K Series

P-5289

## - DELIVERY SECTION -



**GRIPPER FINGER** - K-Series - Delivery.

Without urethane . . . . . HE-521050

With urethane . . . . . HE-521020

# REPLACEMENT PARTS FOR HEIDELBERG K-SERIES

## GRIPPER BAR ASSEMBLIES - All K-Series

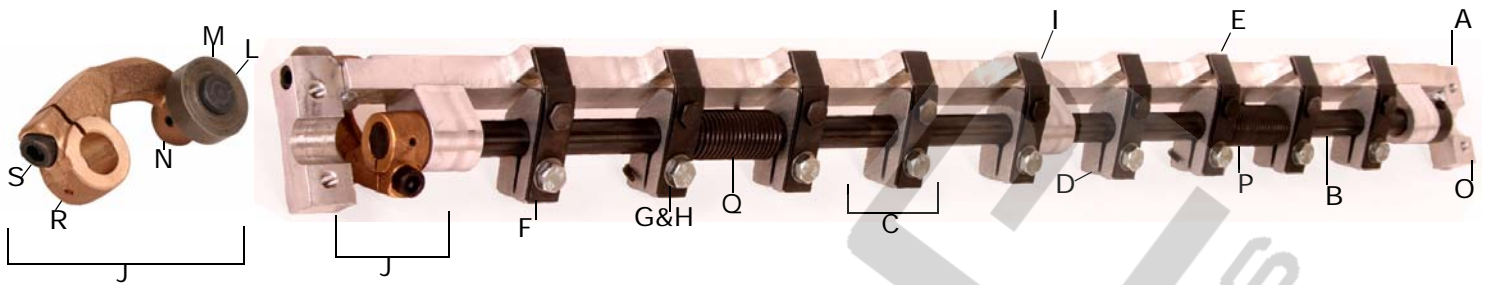

- COMPLETE (KOR, KORA, KORD 62)** HE-KØR0990
- COMPLETE (KORD 64)** . . . . . HE-KØRD0990
- COMPLETE (KORS)** . . . . . HE-KØRS0990

- (A) Anvil (KOR, KORA, KORD 62) . . . . . HE-KØR1090
- (A) Anvil (KORD 64) . . . . . HE-KØRD1090
- (A) Anvil (KORS) . . . . . HE-KØRS1090
- (B) Shaft (KOR, KORA, KORD 62) . . . . . HE-KØR1060
- (B) Shaft (KORD 64) . . . . . HE-KØRD1060
- (B) Shaft (KORS) . . . . . HE-KØRS1060
- (C) \*Holder assembly complete . . . . . HE-521000
- (D) \*\*Holder . . . . . HE-521061
- (E) \*\*Finger with urethane . . . . . HE-521020
- (F) \*\*Backing plate . . . . . HE-521062
- (G) \*\*Holding screw . . . . . P-2003
- (H) \*\*Belleville washer . . . . . P-651
- (I) \*\*Shoulder screw . . . . . P-8161
- (J) \*Arm assy. (KOR, KORA, KORD62) . . . . . HE-KØR1040
- (J) \*Arm assy. (KORS, KORD 64) . . . . . HE-KØRD1040
- (K) \*\*Arm only (KOR, KORA, KORD62) . . . . . HE-KØR1041
- (K) \*\*Arm only (KORS, KORD 64) . . . . . HE-KØRD1041
- (L) \*\*Cam roller stud (All K-Series) . . . . . P-7169
- (M) \*\*Cam roller (All K-Series) . . . . . P-6840
- (N) \*\*Pin (All K-Series) . . . . . P-1894
- (O) Collar (All K-Series) . . . . . P-6739
- (P) Spring (GTO 46 & 52) . . . . . HE-521080
- (Q) Spring (GTO 52 only) . . . . . HE-521085
- (R) Pin . . . . . P-2834
- (S) Screw (All K-Series) . . . . . P-2101

\*indicates a sub-assembly.  
 \*\*indicates components of a sub-assembly.  
 Note: Item (B) Shaft must be taper reamed for pins in field.

# REPLACEMENT PARTS FOR HEIDELBERG K-SERIES



## GRIPPER CHAINS

KOR . . . . .	HE-KØR1100
KORD . . . . .	HE-KØRD1100
KORS . . . . .	HE-KØRS1100

## GRIPPER CHAIN CONNECTING LINKS - K-Series

(Used to connect the ends of the chain together. These are not gripper bar carrier links.)

**A**



**B**



- (A) KOR, KORD, KORS (also used on M-Series) . . .P-8761
- (B) KOR, KORD, KORS (offset link) . . . . .P-8762

## GRIPPER BAR CARRIER LINKS - K-Series

**A**



**B**



**C**



- (A) Operators side . . . . . P-8732
- (A) Non-operators side . . . . . P-8742
- (B) Star rod carrier link (also used on M-Series) . . . . P-8734
- (C) Connecting plate . . . . . P-8712-P

## SPRING - K-Series - For ratchet pawl on delivery section.



P-362130

## DELIVERY SIDE JOGGER - All K-Series - O.S. / D.S.

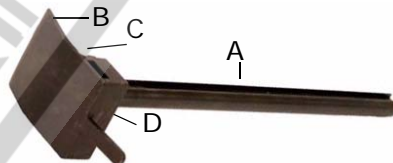

- Complete . . . . . HE-KS2160
- (A) Shaft . . . . . HE-KS2160-S
- (B) Jogger plate . . . . . HE-KS2160-P
- (C) Set screw (to lock plate to shaft) . . . . . P-865
- (D) Set screw (to lock guide extension) . . . . . P-2517



# REPLACEMENT PARTS FOR HEIDELBERG K-SERIES

## FRONT SHEET STOPS - KORA, KORD 62 / 64, KORS

A



B



C



- (A) KORA, KORD 62 (center) . . . . . HE-KØRD2283-62  
 (B) KORA, KORD 64, KORS (center) . . . . . HE-KØRD2283-64  
 (C) KORA, KORD 64, KORS (side) . . . . . HE-KØRD2284

## SHEET STOPS - KORD 62 / KORD 64

A



B



C



D



- (A) KORD 62 . . . . . HE-KØRD2281-62  
 [for ser. #335790 & below otherwise use HE-KØRD2281-64]  
 (B) KORD 62 & 64 . . . . . HE-KØRD2282-62  
 [for ser. #335791 & above otherwise use HE-KØRD2281-64]  
 (C) KORD 64 . . . . . HE-KØRD2281-64  
 (D) KORD 64 . . . . . HE-KØRD2282-64  
 [for ser. #335791 & above]

**RUBBER STRIPPER FINGER** - For sheet stops (only D & B) . . . HE-KS15112



**SPRING** - For valve on air pump.

(25 mm X 40 mm) . . . . . HE-KØ280



**VARIABLE SPEED PULLEY** - K-Series

P-4291

- COMES WITH INSTALLATION INSTRUCTIONS.

# REPLACEMENT PARTS FOR HEIDELBERG K-SERIES

**POWDER TUBE ASSEMBLY** - All K-Series (also used on GTO 46 / 52)

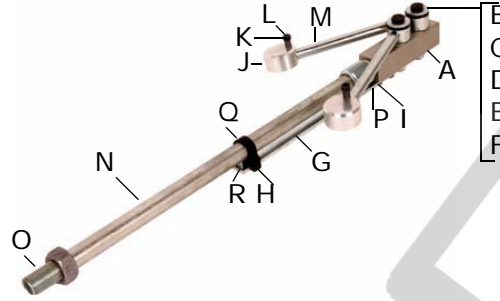

**Complete - Short tube (A - R)**

**Complete - Long tube (A - R)**

**Powder tube sub assembly (A - M)**

- (A) Manifold
- (B) Screw
- (C) Washer
- (D) Gasket
- (E) Rubber washer
- (F) Lock nut
- (G) Powder tube guide
- (H) Stop screw
- (I) Screw

**Spray nozzle sub assembly (J - M)**

- (J) Nozzle - 3 Holes
- (J) Nozzle - 8 Holes
- (K) Screw
- (L) Spring
- (M) Nozzle tube

**Powder tube sub assembly - Short (N - R)**

**Powder tube sub assembly - Long (N - R)**

- (N) Short tube (for HE-KØR6030)
- (N) Long tube (for HE-KØR6040)
- (O) Nut
- (P) Compression nut with gasket
- (Q) Guide collar
- (R) Set screw

- HE-KØR6030
- HE-KØR6040
- HE-KØR6046
- HE-KØR6050
- P-2044
- P-592
- P-6422
- P-11036
- P-2616
- HE-KØR6051
- P-2351
- P-2082
- HE-KØR6047
- HE-KØR6056
- HE-466056
- P-2921
- P-15601
- HE-KØR6055
- HE-KØR6035
- HE-KØR6045
- HE-KØR6052
- HE-KØR6053
- P-2681
- P-2941
- HE-KØR6054
- P-2499



**Star Wheel - Star/Pointed Surface**  
(For the K/S/M Series, SM 102/72/74)

P-30842-0



**Star Wheel - Smooth/Plain**  
(for the K/S/M Series, SM 102/72/74)

P-30842-S



**Star Wheel - Knurled/Dimple**  
(for the K/S/M Series, SM 102/72/74)

P-30842-K



# REPLACEMENT PARTS FOR HEIDELBERG K-SERIES



### Star Rod Assemblies

KOR, KORA, KORD 62 . . . . . HE-KORD3170-62  
 KORD 64. . . . . HE-KORD3170-64

### ROLLER KITS

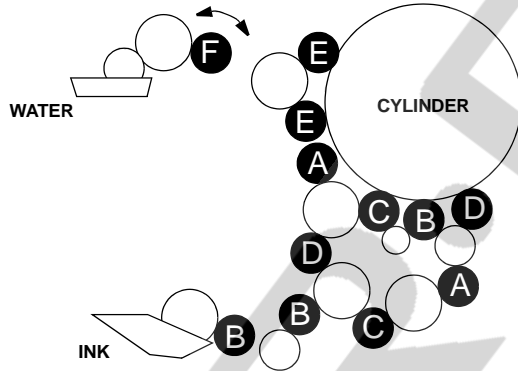

#### KORD 62

INK ROLLER KIT . . . . . P-31656

Consists of:

- (2) Blue Form / Distributor [ A ] . . . . . P-30916
- (3) Red Form / Distributor / Ductor [ B ] . . . . . P-30918
- (2) White Form / Distributor / Ductor [ C ] . . . . . P-30917
- (2) Brown Form / Distributor / Ductor [ D ] . . . . . P-30919

#### KORD 62

BAREBACK WATER ROLLER KIT . . . . . P-31674

Consists of:

- (2) Bareback Water Form [ E ] . . . . . P-31950
- (1) Water Ductor [ F ] . . . . . P-30985

#### KORD 64

INK & WATER ROLLER KIT . . . . . P-30494

Consists of:

- (2) Blue Form / Distributor [ A ] . . . . . P-30910
- (2) White Form / Distributor [ C ] . . . . . P-30911
- (3) Red Form / Distributor / Ductor [ B ] . . . . . P-30912
- (2) Brown Form / Distributor [ D ] . . . . . P-30913
- (3) Green (3M Sleeve) . . . . . P-30914



**Medium Bipin Fluorescent - KORD**  
 (Chain Delivery)

P-9720



**Grease Gun Set - K Series**  
 (also for SM 102/72, GT0 46/52, M and S Series)

P-5935

**Grease Cartridge only**

P-5993

# REPLACEMENT PARTS FOR HEIDELBERG M-SERIES



**TRANSFER GRIPPER - MOZ**  
(also used on Speedmaster & SORK)

HE-MT225

## BLANKET BARS ASSEMBLY

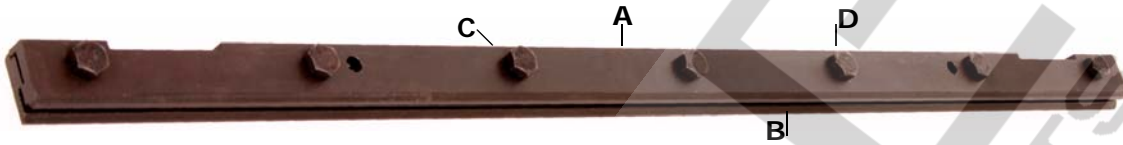

- (A) Upper clamp . . . . . HE-MØ258
- (B) Lower clamp . . . . . HE-MØ256
- (C) Screw (7 per assembly) . . . . . P-2009
- (D) Spring (6 per assembly) . . . . . P-12319



## GRIPPER CHAIN

- COMPLETE** . . . . . HE-MØ1100
- Connecting link . . . . . P-8761



## STAR WHEEL ROD

- COMPLETE** with spring . . . . . HE-MØ3170
- Spring only . . . . . HE-463110

## ROLLER KITS

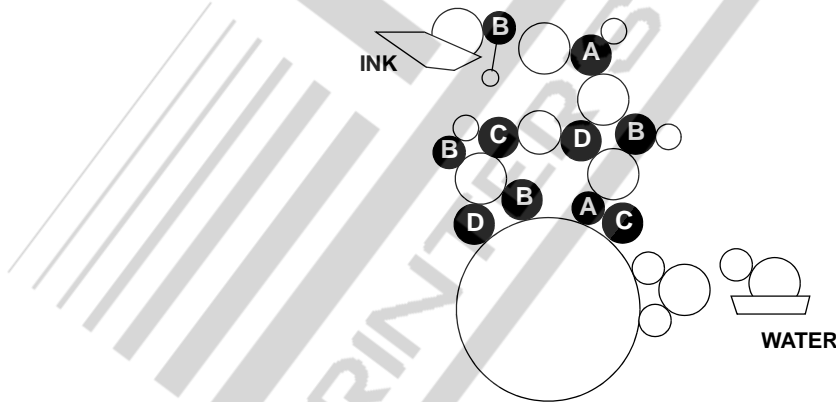

- MO (conventional)
- INK ROLLER KIT . . . . . P-31839

Consists of:

- (2) Blue Form / Distributor [ A ] . . . . . P-31840
- (4) Red Form / Distributor / Ductor [ B ] . . . . . P-31841
- (2) White Form / Distributor [ C ] . . . . . P-31842
- (2) Yellow Form / Distributor [ D ] . . . . . P-31843

# REPLACEMENT PARTS FOR HEIDELBERG M-SERIES

## GRIPPER FINGER - All M-Series



- Without urethane . . . . . HE-M01050
- With urethane . . . . . HE-M01020

## Roller Tire

A



B

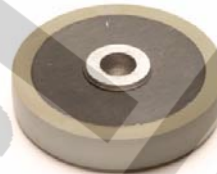

- (A) Forwarding (Plastic) . . . . . HE-M0454-P
- (B) Hold Down (Steel) . . . . . HE-M0454-S

## Jogger Rod - M Series D.S.



HE-M01660

## Impression Gripper - GTO 52VP and M-Series



- With Urethane . . . . . HE-M0237
- Without Urethane . . . . . HE-M0245

## Compression Spring - For Impression Cylinder Shaft



HE-M0153

## Jogger Rod Sleeve - SPD, M & S-Series



HE-M01669

## Blue Polyurethane Hose (per meter)



- ID 9mm OD 11mm . . . . . P-9558
- ID 4mm OD 6mm . . . . . P-9557
- ID 2.6mm OD 4mm . . . . . P-9531

# REPLACEMENT PARTS FOR HEIDELBERG M-SERIES



**ALColor Drive Gear - M Series**

HE-M0358AD

A



**Journal**

(A) D.S. . . . . . HE-M0440

B



(B) O.S. . . . . . HE-M0453

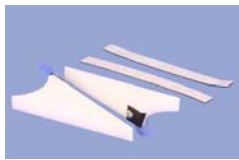

**Ink Fountain End Blocks - MO Series**

O.S. & D.S. (Set of 2) . . . . . HE-M0566



**Hickey Removers**

SORS, SORD, SORM, MO . . . . . P-29981



**Sheet Smoother - M Series**

HE-M0434



**Spring - M Series Delivery Gripper Bar**

Non-Operator Side . . . . . HE-M01080

Operator Side . . . . . HE-M01081



**Adjusting Worm Gear**

HE-M0416



**Bipin Fluorescent - MO . . . . . P-9763**

**Medium Wave Infrared Lamp- MO . . . . . P-9765**

# REPLACEMENT PARTS FOR HEIDELBERG QUICKMASTER 46/46DI

## - FEEDER SECTION -

**SHEET SEPARATOR BAR** - Quickmaster 46 / 46DI



HE-46117QM



**SHEET STEADIER BRUSH KIT** - 46DI

(includes all 9 brushes needed with screws)

COMPLETE . . . . .	P-31134
Brush only . . . . .	HE-46420QM
Screw . . . . .	P-2022

## - INK SECTION & WATER SECTION -



**INK FOUNTAIN ADJUSTING SCREW** - Quickmaster 46  
(also used on TOK)

P-2021



**DOG AND WORM** - Quickmaster 46

Worm & Dog Set . . . . .	HE-46464QM-K
Worm . . . . .	HE-46464QM
Dog . . . . .	HE-46428QM
Pin . . . . .	P-2834

**INK FOUNTAIN BLADE**



QUICKMASTER . . . . . HE-46079QM

**TEFLON DAMPENING ROLLER SEALS** - 46 & 46DI



A

(A) Set of 1 each L.H. & R.H (95mm). . . . .	P-31161
(B) Set of 1 each L.H. & R.H (102mm). . . . .	P-31181



# REPLACEMENT PARTS FOR HEIDELBERG QUICKMASTER 46/46DI



## DAMPENING FELTS

Quickmaster 46 (no holes) . . . . . P-11739



Quickmaster 46DI (3 holes) . . . . . P-11740



## Blanket Washup Roller (also for Printmaster 46)

P-34H18

## - DELIVERY SECTION -

### GRIPPER BAR ASSEMBLY - Quickmaster 46 / 46DI

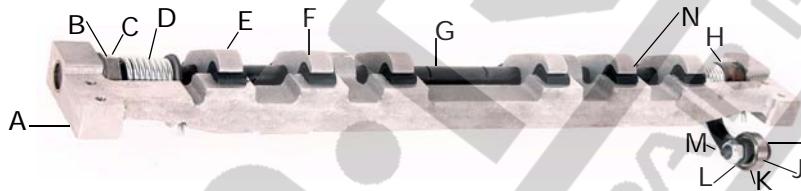

**COMPLETE** (46QM) . . . . . HE-460990QM

**COMPLETE** (46DI) . . . . . HE-460990QMDI

- (A) Anvil for 46(comes with P-11904 (Angled Pad) . . . HE-461090QM
- (A) Anvil for 46DI(comes with P-5631 (Flat Pad) . . . . HE-461090QMDI
- (B) Set screw(not shown) . . . . . P-2506
- (C) Adjusting collar . . . . . P-6858
- (D) Gripper spring . . . . . HE-461080QM
- (E) Delivery gripper for 46 . . . . . HE-461020QM
- (E) Delivery gripper for 46DI . . . . . HE-461020QMDI
- (F) Screw(not shown) . . . . . P-2112
- (G) Gripper shaft . . . . . HE-461060QM
- (H) Taper pin . . . . . P-2810

### GRIPPER LEVER ASSEMBLY . . . . . HE-461040QM

(Consists of I thru M - also included with complete assembly)

- (I) Screw . . . . . P-2103
- (J) Washer . . . . . P-5569
- (K) Ball bearing . . . . . P-11113
- (L) Gripper lever only . . . . . HE-461041QM
- (M) Stop nut . . . . . P-2610
- (N) Rubber pad (Flat) . . . . . P-5631
- (N) Rubber pad (angled) . . . . . P-11904



# REPLACEMENT PARTS FOR HEIDELBERG QUICKMASTER 46/46DI



## GRIPPER CHAINS

QUICKMASTER 46 . . . . . HE-461100QM  
QUICKMASTER 46DI . . . . HE-461100DI



## TAPE TRACK - Quickmaster 46DI - For guide pulley.

HE-463130DI



## Pump Filter - Quickmaster 46

P-9470

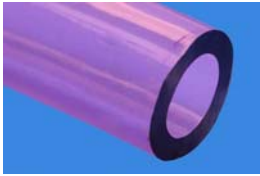

## Hose - Quickmaster 46 and Quickmaster 46DI (also for M Series and TOK)

59 inches

P-5248

18 inches

P-5258

6 1/2 inches

P-5263



## Gripper - Impression Cylinder (also for TOK/TOM)

HE-46237QM



## Plate Spring

4mm . . . . . HE-46099QM-4mm

6mm . . . . . HE-46099QM-6mm



## Gear-Metering Roll

HE-46555QM

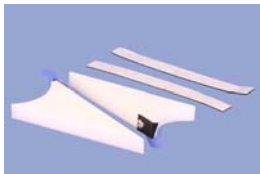

## Ink Fountain End Blocks

Set of 2 . . . . . HE-46566QMDI



# REPLACEMENT PARTS FOR HEIDELBERG SPEEDMASTER 52/72/74/102

## - FEEDER SECTION -



**FORWARDING RETAINER SPRING** - Speedmaster 72 / 102  
On suction head.

HE-S0842



**SPRING** - Speedmaster 72 / 102  
For forwarding sucker.

(21 mm X 50 mm) . . . . . HE-72770

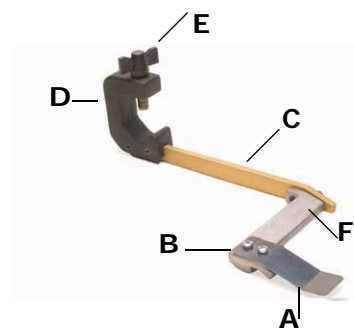

**SHEET SMOOTHER** - Speedmaster 72 / 102 (also used all S-Series)

**COMPLETE** (Operators side) . . . HE-S0562

**COMPLETE** (Drive side) . . . . . HE-S0568

(A) Spring plate . . . . . HE-S0779

(B) Screw . . . . . P-10207

(C) Bar only \*\* . . . . . HE-S0483

(D) Block . . . . . HE-S0359

(E) Thumb screw . . . . . P-2923

(F) Spacer piece (oper. side) . . . . HE-S0541

(F) Spacer piece (drive side) . . . . HE-S0573

\*\* bar (A) alone have no holes and is only sold with complete assembly.

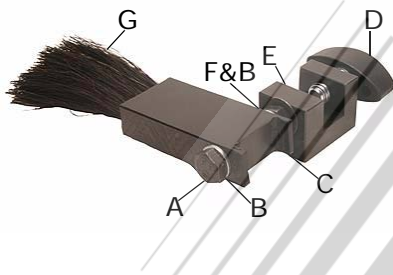

**SHEET STEADIER BRUSH** - Speedmaster 72 / 102  
(also used on all S-Series)

Complete . . . . . HE-SR467

(A) Hex head screw . . . . . P-2077

(B) Flat washer . . . . . P-581

(C) Nut . . . . . P-2603

(D) Thumb screw . . . . . P-2924

(E) Bracket only . . . . . HE-SR485

(F) Spring washer . . . . . P-654

(G) Sheet steadier brush . . . . . HE-SR475



**SHEET STOP** - All S-Series

HE-102100



**SPRING** - Speedmaster 72 / 102  
For impression cylinder gripper.

(14.5 mm X 45.0 mm) . . . . . HE-102843

# REPLACEMENT PARTS FOR HEIDELBERG SPEEDMASTER 52/72/74/102



**SPRING** - Speedmaster 72 / 102  
For transfer gripper.

(13.5 mm X 37 mm) . . . . . HE-102660



**FEED DRUM GRIPPER** - Speedmaster 72 / 102

HE-72225

**BLANKET BAR ASSEMBLIES**

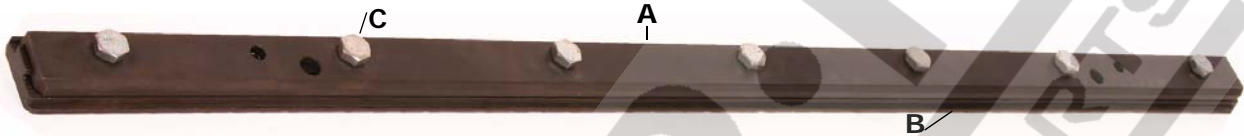

**COMPLETE** (Speedmaster 72) - Pictured . . . . . HE-72252  
**COMPLETE** (Speedmaster 102) . . . . . HE-102252

- (A) Upper clamp (72) - Pictured . . . . . HE-72258
- (A) Upper clamp (102) . . . . . HE-102258
- (B) Lower clamp (72) - Pictured . . . . . HE-72256
- (B) Lower clamp (102) . . . . . HE-102256
- (C) Screw ( 72, 7 per assy. / 102, 10 per assy.) . . . . . P-2010
- (D) Spring (72, 4 per assy. / 102, 5 per assy.) (not shown) . . . . . P-12319



**Guide Roller** - Speedmaster 72/102  
(for S and M-Series)

P-72184



**Suction Tape** - Speedmaster 74

Gray (Set of 3) . . . . . P-29988  
 Yellow (Set of 3) . . . . . P-29989

**- INK & WATER SECTION -**



**SPRING** - Speedmaster 102  
On ink unit.

(11.5 mm X 60 mm) . . . . . HE-102673

# REPLACEMENT PARTS FOR HEIDELBERG SPEEDMASTER 52/72/74/102

---

## INK FOUNTAIN BLADES



Speedmaster 72 (also for SORM) . . . . . HE-SØRM095  
 Speedmaster 102 (also for SORSZ) . . . . . HE-SØRSZ095

---



**INK BLADE ADJUSTING SCREW** - Speedmaster 72 / 102  
 (also used on GTO 46/52, M-Series, S-Series)

P-2928

---

## INK FOUNTAIN STOP PLATES

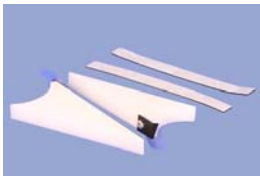

**Speedmaster 72** - Set of OS & NOS . . . . . HE-72566  
**Speedmaster 74** - Set of OS & NOS . . . . . HE-74566  
**Speedmaster 102** - Set of OS & NOS . . . . . HE-102566  
**Speedmaster 52** - Set of OS & NOS . . . . . HE-52566SM

Spring plate for 72 / 102 (O.S.) . . . . . HE-72261  
 Spring plate for 72 / 102 (N.O.S.) . . . . . HE-72082  
 Hickey picker for 72 / 102 . . . . . P-31108  
 Screw for Hickey Picker . . . . . P-9224

---



**Alcolor Damp Drive Gear** - Long  
 (for Speedmaster 102)

HE-102358AD

---



**Segment for Cam Gear**  
 (for Alcolor Speedmaster 102)

HE-102366AD

---



**Intermediate Gear**  
 (for Alcolor Speedmaster 102)

Large . . . . . HE-102368-L  
 Small . . . . . HE-102368-S

---

REPLACEMENT PARTS FOR HEIDELBERG  
**SPEEDMASTER 52/72/74/102**

---



**Journal O.S.** - for Metering Roll  
(for Speedmaster 102)

HE-102453



**Ink Spacer** - Speedmaster 72  
(also for S-series)

P-6729



**Dampening Spacer** - Speedmaster 72/102  
(also for S-Series)

P-6731



**Adjusting Nut** - Alcolor Speedmaster 102

Meter Roll Drive Shaft . . . . . P-6765

---

**- DELIVERY SECTION -**

---



**GRIPPER PADS** - Speedmaster 72 / 102

- (A) Ultraviolet / infrared dryers . . . . . HE-721061-U
- (B) Standard . . . . . HE-721061



**CAM ROLLER** - For Gripper Bar Operating Lever

P-6871



**GRIPPER BAR OPERATING LEVER** - Speedmaster 72 / 102

HE-721040



**Reversing Gripper** - Plain Tip  
(for Speedmaster 72, 102, M-Series)

HE-721020-R

# REPLACEMENT PARTS FOR HEIDELBERG SPEEDMASTER 52/72/74/102

## STAR ROD SHAFT ASSEMBLIES (COMPLETE ASSEMBLY)

Speedmaster 72 (also used on SORMZ) . . . HE-SM3170

Speedmaster 102 (also used on SORSZ) . . . HE-SS3170

Spring for both. . . . . HE-SØR3110

NOTE: THESE DO NOT INCLUDE STAR BRUSHES OR WHEELS.



## STAR ROD BRUSHES

**COMPLETE** . . . . . P-30842

Brush only . . . . . P-30842-B

Collar only . . . . . P-30842-C

Rubber O-Ring . . . . . P-553



## GRIPPER CHAIN - Speedmaster 72

HE-721100



## Pneumatic Spring - Speedmaster 102

Delivery . . . . . P-29990

Safety Guard . . . . . P-29991



## Delivery Blowdown Fan - Speedmaster 102

(also for M Series)

Terminal Connection . . . . . P-4204

Wire Connection . . . . . P-4205



## Starter - Speedmaster 52/102

(also for T0K)

P-9850



## Paper Retriever - Speedmaster 102/72

(also for GT0 52 and M Series)

P-5999



## Fluorescent Lamp - Speedmaster 102

P-9855





# REPLACEMENT PARTS FOR HEIDELBERG SPEEDMASTER 52/72/74/102

## GRIPPER BAR ASSEMBLY - Speedmaster 72

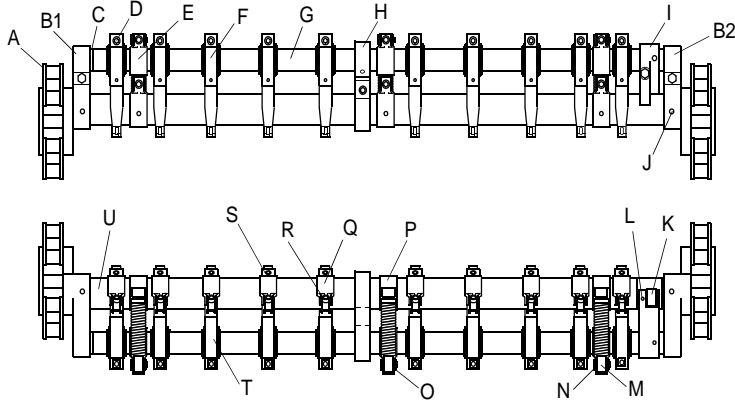

<b>COMPLETE</b> .....	HE-720990
<b>COMPLETE</b> for ultraviolet .....	HE-1020990-U
(A) Chain link - 4 ea. ....	P-8715
(B-1)Carrier link assembly - operators side. ....	HE-720991
(B-1)Carrier link assembly - operators side. ....	HE-1020991
(B-2)Carrier link assembly - non-operators side ....	HE-720992
(B-2)Carrier link assembly - non-operators side ....	HE-1020992
- Link only - for (B-1) .....	HE-720991-L
- Link only - for (B-1) .....	HE-1020991-L
- Link only - for (B-2) .....	HE-720992-L
- Link only - for (B-2) .....	HE-1020992-L
- Inner chain link - 2 for each assembly .....	P-8715
- Needle bearing .....	P-3461
- Dowel pin for P-8715 - 2 for each assembly .....	P-2898
(C) Washer .....	P-2738
(D) Screw .....	P-2103
(E) Clamping piece .....	HE-721066
(F) Finger .....	HE-721020
(G) Gripper supporting shaft .....	HE-721060
(G) Gripper supporting shaft .....	HE-1021060
(H) Center pivot bearing .....	HE-721092
( I ) Gripper operating lever .....	HE-721040
(J) Taper pin - 3 per complete assembly .....	P-2865
(K) Cam roller .....	P-6871
(L) Set screw .....	P-10017
(M) Spring guide .....	P-2970
(N) Pin .....	P-4768
(O) E-Ring .....	P-2759
(P) Clamp .....	HE-721067
(Q) Clamping piece .....	HE-721065
- Screw .....	P-2103
- Nut .....	P-2603
- Lockwasher .....	P-10836
(R) Screw .....	P-2143
(S) Gripper pad for Ultraviolet (Zinc Plated) .....	HE-721061-U
(T) Clamp .....	HE-721064
(U) Shaft .....	HE-721090
(U) Shaft .....	HE-1021090



# REPLACEMENT PARTS FOR HEIDELBERG SPEEDMASTER 52/72/74/102



## Grooved Gripper Pads - Speedmaster 72

- (A) Cross Grooved . . . . . HE-72422-CG
- (B) Parallel Grooved . . . . . HE-72422-PG

## Grooved Gripper Pads - Speedmaster 102

- (A) Cross Grooved . . . . . HE-102422-CG
- (B) Parallel Grooved . . . . . HE-102422-PG
- (C) Diamond Grooved . . . . . HE-102422-DG

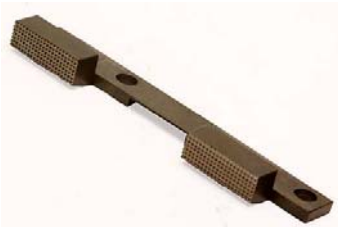

## Gripper Pad - Cross Groove

- Operator's Side . . . . . HE-72442-0
- Center . . . . . HE-72442-C
- Drive Side . . . . . HE-72442-D



## Hickey Remover - Speedmaster 74

P-29982



## Hickey Remover - Speedmaster 52

P-29983



## Miniature Bipin Filament Lamp - Speedmaster 74/102, M-Series

P-4230



## Numbering Head - Backward 3/16 Gothic

(For Speedmaster 52, Quickmaster 46 and GT0 series)

- Convex (Vertical) . . . . . P-31026
- Straight (Horizontal) . . . . . P-31028

# REPLACEMENT PARTS FOR HEIDELBERG S-SERIES

## - FEEDER SECTION -



**SPRING** - S-Series  
For lifting sucker.

HE-S0170



**FORWARDING RETAINING SPRING** - S-Series  
(also used on M-Series & Speedmaster 72 / 102)

HE-S0842



**SHEET STOP** - All S-Series  
(also used on M-Series & Speedmaster 72 / 102)

HE-102100



**SHEET SMOOTHER PLATE SPRING**  
(also used on Speedmaster 72 / 102)

(A) SORZ, SORDZ, SORSZ. . . . . HE-S0588

(B) SORKZ, SORMZ. . . . . HE-S0924

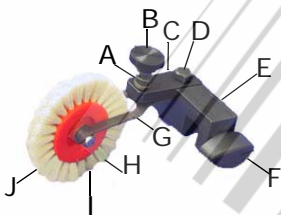

**FEEDER BRUSH WHEEL** - S-Series, Speedmaster 72 / 102

**COMPLETE** (white brush) . . . . . HE-SR403

**COMPLETE** (black brush) . . . . . HE-SR767

- (A) Spring . . . . . P-12319
- (B) Thumb screw . . . . . P-2903
- (C) Small bracket . . . . . HE-SR498
- (D) Hex head screw. . . . . P-2043
- (E) Large bracket . . . . . HE-SR473
- (F) Thumb screw . . . . . P-2924
- (G) Holder . . . . . HE-SR492
- (H) Pin. . . . . P-4777
- (I) Brush wheel (WHITE). . . . . HE-SR420
- (I) Brush wheel (BLACK). . . . . HE-SR500
- (J) E-Ring for P-4777 . . . . . P-2753

WHITE BRUSH IS FOR  
PAPER STOCK

BLACK BRUSH IS FOR  
CARDBOARD STOCK.

# REPLACEMENT PARTS FOR HEIDELBERG S-SERIES

## SHEET STEADIER BRUSH - All S-Series (also used on Speedmaster 72 / 102)

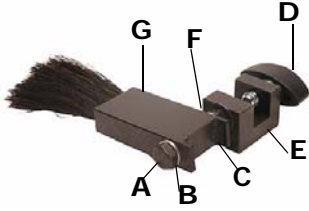

COMPLETE . . . . .	HE-SR467
(A) Hex head screw . . . . .	P-2077
(B) Flat washer . . . . .	P-581
(C) Nut . . . . .	P-2603
(D) Thumb screw . . . . .	P-2924
(E) Bracket only . . . . .	HE-SR485
(F) Spring washer . . . . .	P-654
(G) Sheet steadier brush . . . . .	HE-SR475

## SHEET SMOOTHER - All S-Series (also used on Speedmaster 72 / 102)

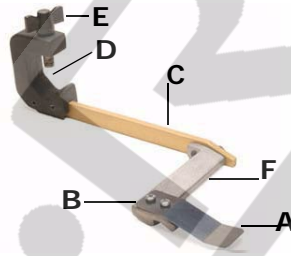

<b>COMPLETE</b> (Operators side) . . . . .	HE-S0562
<b>COMPLETE</b> (Drive side) . . . . .	HE-S0568

(A) Spring plate . . . . .	HE-S0779
(B) Screw . . . . .	P-10207
(C) Bar only ** . . . . .	HE-S0483
(D) Block . . . . .	HE-S0359
(E) Thumb screw . . . . .	P-2923
(F) Spacer piece (oper. side) . . . . .	HE-S0541
(F) Spacer piece (drive side) . . . . .	HE-S0573

\*\* bars (A) alone have no holes and need to be drilled per your existing block.

## SHEET SMOOTHER - SB-Series

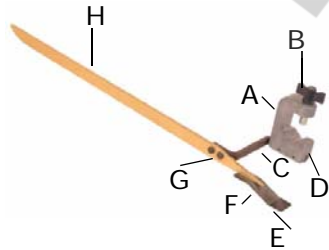

<b>COMPLETE</b> . . . . .	HE-SBD568
(A) Block only . . . . .	HE-SBD359
(B) Thumb screw . . . . .	P-2923
(C) Spacer bracket . . . . .	HE-SBD573
(D) Roll pin . . . . .	P-516
(E) Plate spring . . . . .	HE-S0779
(F) Pan head screw . . . . .	P-2355
(G) Hex head screw . . . . .	P-2031
(H) Bar only . . . . .	HE-SBD483

# REPLACEMENT PARTS FOR HEIDELBERG S-SERIES

## - CYLINDER SECTION -



**SPRING** - All S-Series - For feed drum

HE-SØ179



**AXIAL BEARING DISK** - For feed drum.

P-3422

**DISK WASHER (RACE)**

P-2722



**FEED DRUM GRIPPER** - All S-Series  
(also used on M-Series & Speedmaster 72 / 102)

HE-72225



**TRANSFER GRIPPER** - SORK  
(also used on Speedmaster & MOZ)

HE-MT225



**IMPRESSION GRIPPER** - SORKZ

HE-SK245

### BLANKET BAR ASSEMBLIES



COMPLETE (**SORDZ**) . . . . . HE-SØRDZ252  
 COMPLETE (**SORKZ**) . . . . . HE-SØRKZ252  
 COMPLETE (**SORZ**) . . . . . HE-SØRZ252

- (A) Upper clamp (**SORDZ**) . . . . . HE-SØRDZ258
- (A) Upper clamp (**SORKZ**) . . . . . HE-SØRKZ258
- (A) Upper clamp (**SORZ**) . . . . . HE-SØRZ258
- (B) Lower clamp (**SORDZ**) . . . . . HE-SØRDZ256
- (B) Lower clamp (**SORKZ**) . . . . . HE-SØRKZ256
- (B) Lower clamp (**SORZ**) . . . . . HE-SØRZ256
- (C) Spring (**All models**)(not shown) . . . . . P-12319
- (D) Screw (**All Models**) . . . . . P-2009

# REPLACEMENT PARTS FOR HEIDELBERG S-SERIES

## - INK & WATER SECTION -

### INK FOUNTAIN BLADES



SORDZ . . . . .	HE-SØRDZ095
SORKZ . . . . .	HE-SØRKZ095
SORM (also for Speedmaster 72) . . . . .	HE-SØRM095
SORSZ (also for Speedmaster 102) . . . . .	HE-SØRSZ095
SORZ . . . . .	HE-SØRZ095

### OVER RUNNING CLUTCH ASSEMBLY - All S-Series

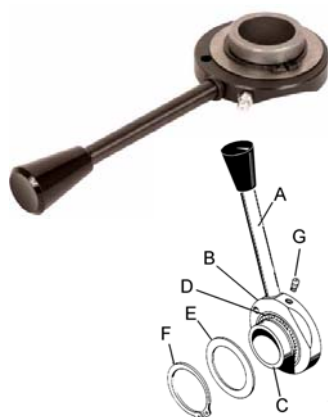

**COMPLETE** . . . . . HE-SØ259

- (A) Lever . . . . . P-320416
- (B) Collar . . . . . P-6786
- (C) Bearing race . . . . . HE-SØ261
- (D) One way clutch bearing . . . . . P-3447
- (E) Washer . . . . . P-11810
- (F) Retaining ring . . . . . P-2789
- (G) Grease fitting . . . . . P-3677

### WORM HOUSING - S-Series - For ink distributor rollers.



HE-SØ418

### SPRING - All S-Series

For dampening roller journal and vibrator control spring rod.  
(also for Speedmaster 72 / 102)



HE-SØR525

### SHUT OFF VALVE - For water bottles.



P-11956

# REPLACEMENT PARTS FOR HEIDELBERG S-SERIES

## - DELIVERY SECTION -



**GRIPPER CHAIN - SORD**

HE-SØRD1100



**DELIVERY GRIPPER - All S-Series**

Gripper only

HE-SK1000



**GRIPPER HOLDER - All S-Series**

HE-721064

### STAR ROD ASSEMBLY (COMPLETE ASSEMBLY)



- SORZ** . . . . . HE-SR3170
  - SORKZ** . . . . . HE-SK3170
  - SORMZ** (also used on Speedmaster 72) . . . HE-SM3170
  - SORSZ** (also used on Speedmaster 102) . . HE-SS3170
  - S-Cylinder** (33 3/4 O.A.L.) . . . . . HE-SCP3170
  - Spring only for all . . . . . HE-SØR3110
- NOTE: THESE DO NOT INCLUDE STAR BRUSHES OR WHEELS.

### STAR ROD ASSEMBLY

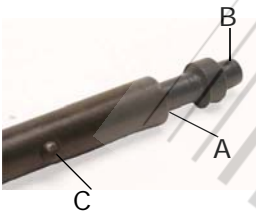

- SORDZ** - Complete . . . . . HE-SD3170
- (A) Spring only . . . . . HE-KØR3110
- (B) End pin - (not sold separately) . . . . . P-4779
- (C) Button rivet . . . . . P-10376

NOTE: THESE DO NOT INCLUDE STAR BRUSHES OR WHEELS.

### STAR ROD BRUSHES



- COMPLETE** . . . . . P-30842
- Brush only . . . . . P-30842-B
- Collar only . . . . . P-30842-C
- Rubber O-Ring . . . . . P-553



# REPLACEMENT PARTS FOR HEIDELBERG S-SERIES



**Spring** - For Feed Table  
(for S Series, M Series, SM 102)

HE-S0148



**Jogger Rod**

O.S. . . . . . HE-S01660-0

D.S. . . . . . HE-S01660-D



**Hold Down Roll Complete**

Rubber (SM 102, S, M-SERIES) . . . . . HE-S0434-R

Steel (SM 102 AND S SERIES) . . . . . HE-S0434-S

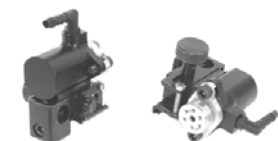

**Forwarding Sucker - S Series**  
(also for SM 72/102 and M Series)

O.S. & D.S Set. . . . . HE-S0990

O.S. . . . . . HE-S0990-OS

D.S. . . . . . HE-S0990-DS



**Commutator - Carbon**  
(25mm x 10mm x 12mm)

P-9769



**Hook - S Series**

P-8704



**Hose - Per Meter**  
(for S and M Series, SM 102/74/52)

P-9511

# REPLACEMENT PARTS FOR HEIDELBERG TOM/TOK

## - CYLINDER SECTION -



SPINDLE - For blanket cylinder

P-27744

## - INK & WATER SECTION -

INK FOUNTAIN STOP PLATE - TOK



HE-T0792

INK FOUNTAIN ADJUSTING SCREW - TOK

(also used on GTO 46 & GTO 52 Numbering device, M-Series, and Quickmaster 46)



P-2021

INK FOUNTAIN BLADE - TOK / TOM



HE-T0095

WATER FOUNTAIN TRAY



TOK / TOM . . . . . HE-T0316

TEFLON SEALS - TOK / TOM - For use on Varn units

1 pack consists of: (1) Right hand seal and (1) left hand seal.



1 Pack only . . . . . P-30713

Set of 5 packs . . . . . P-30833

Set of 10 packs . . . . . P-30734

# REPLACEMENT PARTS FOR HEIDELBERG TOM/TOK

## - DELIVERY SECTION -



### GRIPPER CHAINS - TOK

Sold as a set . . . . . HE-T01100

### GRIPPER BAR ASSEMBLY - TOK



<b>Complete</b> . . . . .	HE-T00990
(A) Anvil . . . . .	HE-T01090
(B) Set screw (not shown) . . . . .	P-2506
(C) Collar . . . . .	P-6728
(D) Shaft . . . . .	HE-T01060
(E) Gripper finger . . . . .	HE-T01020
(F) Cap screw . . . . .	P-2112
(G) Gripper pad . . . . .	P-11904
(H) Gripper spring (short) . . . . .	HE-T01085
(I) Tension collar . . . . .	P-6734
(J) Set screw . . . . .	P-2512
(K) Gripper spring (long) . . . . .	HE-T01080
(L) Taper pin . . . . .	P-2810
(M) Stop nut . . . . .	P-2610
(N) Gripper operating lever . . . . .	HE-T01041
(O) Washer . . . . .	P-580
(P) Ball bearing . . . . .	P-11113
(Q) Screw . . . . .	P-2103
(R) Bushing . . . . .	P-3239



### Carbon Brush - (TOM/TOK)

P-9440

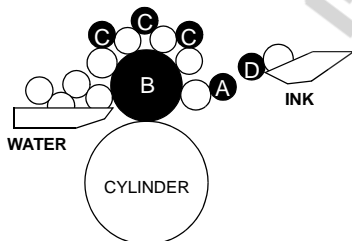

### ROLLER KITS - TOK

INK ROLLER KIT (short) P-30698

Consists of:

- (1) Short Ink Transfer [ A ] P-30932
- (1) Short Ink Form [ B ] P-30934
- (3) Short Ink Rider [ C ] P-30936
- (1) Short Ink Vibrator [ D ] P-30931

# REPLACEMENT PARTS FOR HEIDELBERG WINDMILL 10x15/13x18

## - FEEDER SECTION -



**SPRING** - 10 x 15, 13 x 18  
For throw-off lever on feeder section.

HE-WI934

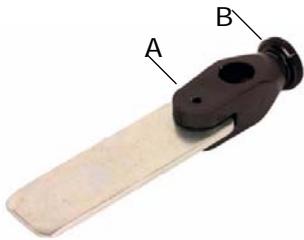

**HOLDER ASSEMBLY** - WINDMILL PLATENS  
(also used on GTO 46 / 52)

COMPLETE. . . . . HE-WI434  
(A) Replacement roll pin . . . . . P-2839  
(B) Replacement thumb screw . . . . . P-2022



**SPRING** - 10 x 15, 13 x 18  
For handle on front lay gauge  
(5.5 mm X 22 mm) . . . . . HE-WI786



**ADJUSTING SCREW** - 10 x 15, 13 x 18  
For lay bar.  
39mm. . . . . HE-WI35-39  
32mm. . . . . HE-WI135-32

## - INK SECTION -



**INK DISTRIBUTOR RUNNER** - 10x15  
HE-WI466



**BALL BEARING** for form rollershaft  
9.5 mm ID . . . . . P-11183  
10 mm ID . . . . . P-838

### INK FORM ROLLER



Windmill 10 x 15 . . . . . P-37H10



**BUFFER SPRING** - 10 x 15, 13 x 18  
For roller carriage.  
(32 mm X 98 mm) . . . . . HE-WI444

# REPLACEMENT PARTS FOR HEIDELBERG WINDMILL 10x15/13x18

## INK FOUNTAIN BLADE



- 10x15 ..... HE-WI095-15
- 13x18 ..... HE-WI095-18



**INK BLADE ADJUSTING SCREWS** - 10x15, 13x18  
(also used on K-Series)

P-2929



**SPRING** - 10 x 15  
On lever for vibrator roller.

(7.5 mm X 24 mm) ..... HE-WI522

## - DELIVERY SECTION -

## GRIPPER BAR ASSEMBLY



- COMPLETE 10x15 ..... HE-WI0990-15
- COMPLETE 13x18 ..... HE-WI0990-18

**SCREW** - For gripper bar opening arm. . . . HE-T1307



**POWDER TUBE NOZZLE**

HE-WI6056



**POWDER NOZZLE TUBE**

HE-WI6055



**BOWDEN CABLE** - 10x15

(Note: Only a section of complete cable is pictured here)

HE-WI3101

# REPLACEMENT PARTS FOR HEIDELBERG

## WINDMILL 10x15/13x18

### - DRIVE SECTION -



**SPRING** - 10 x 15, 13 x 18  
Near clutch tongue on drive mechanism.  
(conical - maj. o.d. 8 mm X o.a.l. 9 mm)

HE-WI640



**SPRING** - 10 x 15, 13 x 18  
For speed pulley.

(67 mm X 256 mm)

HE-WI046

### EMERGENCY KITS - For WINDMILLS 10x15, 13x18

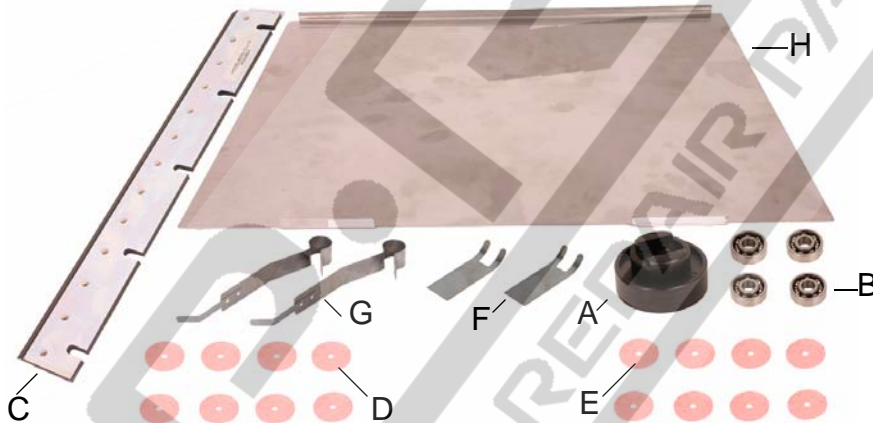

#### WINDMILL 10 X 15 . . . . . P-30840

Consists of:

- (A) Ink distributor runners - (4 pcs.) . . . . . HE-WI466
- (B) Bearings - (4 pcs) . . . . . P-11183
- (C) Wash up blade - (1 pc.) . . . . . P-30209
- (D) Sucker feet (3/16" i.d.) - (8 pcs.) . . . . . P-7566
- (E) Sucker feet (1/8" i.d.) - (8 pcs.) . . . . . P-5234
- (F) Middle sheet separators - (2 pcs.) . . . . . HE-WI117
- (G) End sheet separators - (2 pcs.) . . . . . HE-WI114
- (H) Cylinder jacket - (1 pc.) . . . . . P-30850

#### WINDMILL 13 X 18 . . . . . P-31140

Consists of:

- (B) Bearings for ink distributor runners - (4 pcs. each) . . . . . P-11183
- (C) Wash up blade - (1 pc.) . . . . . P-30243
- (D) Sucker feet (5/32" i.d.) - (20 pcs. each) . . . . . P-7581
- (F) End sheet separators - (6 pcs. each) . . . . . HE-WI114
- (G) Middle sheet separators - (2 pcs. each) . . . . . HE-WI117
- (H) Cylinder jacket - (1 pc.) . . . . . P-30858



# REPLACEMENT PARTS FOR HEIDELBERG SHEET SEPARATORS

## - FEEDER SECTION -

### SHEET SEPARATORS

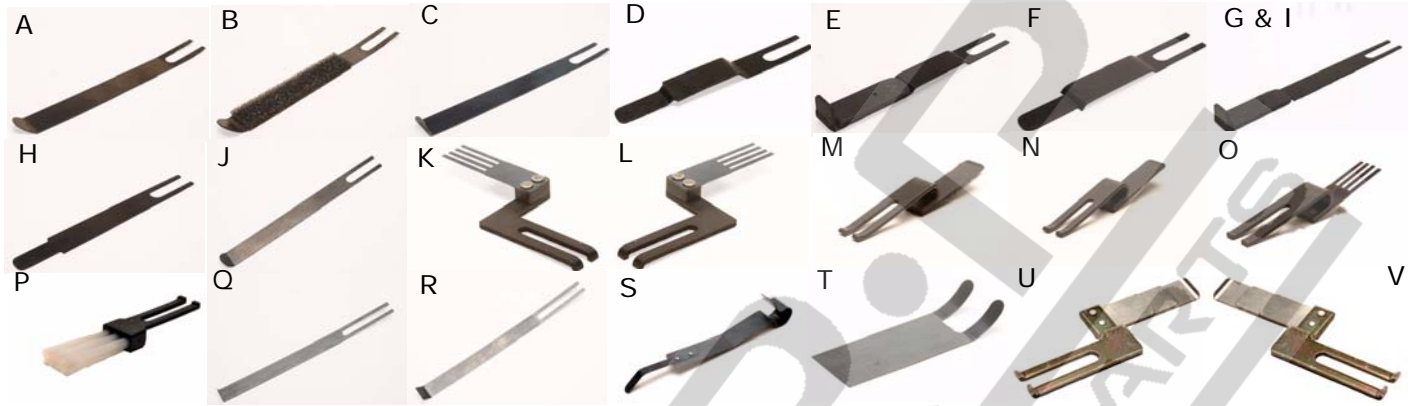

(A)	KORD (45°)	HE-KØ114
(B)	KORD (45° with pad)	HE-KØ420
(C)	KORD (90°)	HE-KØ117
(D)	K-Series	HE-KS117
(E)	K-Series w/hood	HE-KS114
(F)	GTO 46	HE-46117
(G)	GTO 46 (with hood)	HE-46114
(H)	GTO 52	HE-52117
(I)	GTO 52 (with hood)	HE-52118
(J)	GTO 52 (45°)	HE-52114
(K)	GTO 52 Stream Feed - Operators Side	HE-52106
(L)	GTO 52 Stream Feed - Non-op. Side	HE-52107
(M)	M/S Series	HE-SØ117
(N)	M/S Series	HE-SØ114
(O)	M/S Series	HE-SØ106
(P)	M/S Series	HE-SØ107
(Q)	SB Series (90°)	HE-SB117
(R)	SB Series (45°)	HE-SB114
(S)	WINDMILL	HE-WI114
(T)	WINDMILL	HE-WI117
(U)	SPEEDMASTER 52 Stream Feed - Operators Side	HE-52106SM
(V)	SPEEDMASTER 52 Stream Feed - Non-op. Side	HE-52107SM

#### RUBBER HOOD

For HE-KS114, HE-46114, HE-52118  
(key letters "E, G, & I" shown above)

HE-46114-R

#### SHEET SEPARATOR - Quickmaster 46 / 46DI



HE-46117QM

# REPLACEMENT PARTS FOR HEIDELBERG GRIPPER FINGERS

## GRIPPER FINGERS

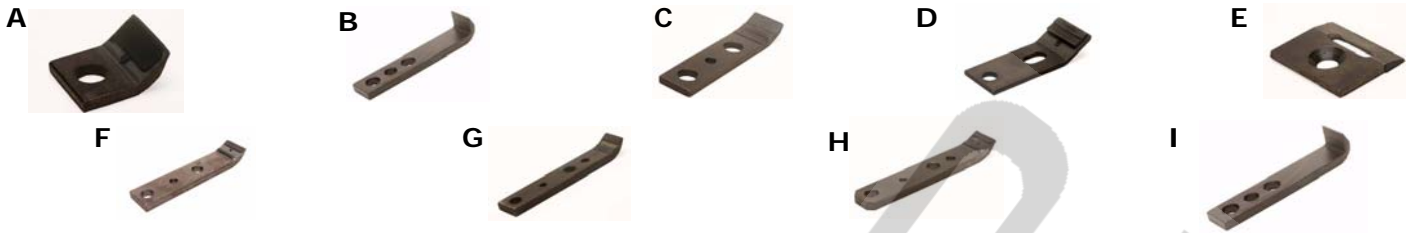

### GTO 46 / 52

- (A) Transfer and Impression drum (urethane tip) . . . HE-52245
- (A) Transfer and Impression drum (plain metal tip) . . HE-52237
- (B) Impression—Perfecting drum (urethane tip) . . . . HE-MØ237

### K-SERIES

- (C) Transfer and Impression drum (metalized grit tip) HE-KØR225

### M-SERIES

- (D) Feed drum (urethane tip) . . . . . HE-72225
- (A) Transfer and Impression drum (urethane tip) . . . HE-52245
- (A) Transfer and Impression drum (plain metal tip) . . HE-52237
- (A) Transfer drum—Coating unit (plain metal tip) . . . HE-52237
- (A) Impression drum—Coating unit (urethane tip) . . . HE-52245
- (A) Impression drum—Coating unit (plain metal tip) . HE-52237

### QUICKMASTER 46 / 46DI & TOM / TOK

- (E) Impression drum (urethane tip) . . . . . HE-46237QM

### S-SERIES

- (F) Transfer and Impression drum (urethane tip) . . . HE-SK237
- (F) Transfer and impression drum (plain metal tip) . . HE-SK245
- (J) Impression cylinder gripper-SBD (urethane tip) . . HE-SBD237

### SPEEDMASTER 72

- (F) Transfer and Impression drum (urethane tip) . . . HE-SK237
- (F) Transfer and Impression drum (plain metal tip) . . HE-SK245
- (G) Impression—Perfecting drum (urethane tip) . . . . HE-72237S
- (G) Impression—Perfecting drum (plain metal tip) . . . HE-72245S
- (G) Transfer drum (large)—Perfecting (urethane tip) . HE-72237S
- (G) Transfer drum (large)—Perfecting (plain metal tip) HE-72245S

### SPEEDMASTER 102

- (H) Feed drum (urethane tip) . . . . . HE-102237
- (H) Feed drum (plain metal tip) . . . . . HE-102245
- (H) Transfer and Impression drum (urethane tip) . . . HE-102237
- (H) Transfer and Impression drum (plain metal tip) . . HE-102245
- ( I ) Impression—Perfecting drum (urethane tip) . . . . HE-102224
- ( I ) Impression—Perfecting drum (plain metal tip) . . . HE-102225

# REPLACEMENT PARTS FOR HEIDELBERG SUCKER FEET, SUCKER BAR SLIDES, FILTERS

## SUCKER FEET



(A)	GTO . . . . .	P-5222
(B)	HEIDELBERG/KLUGE - (7/8" O.D.) . . . . .	P-5210
(B)	K-Series - (1-1/16" O.D.) . . . . .	P-7556
(C)	HEIDELBERG - (5/32" I.D. x 1" O.D.) . . . . .	P-5223
(C)	WINDMILL - (5/32" I.D. x 7/8" O.D.) . . . . .	P-7566
(C)	WINDMILL - (1/8" I.D. x 29/32 O.D.) . . . . .	P-5234
(D)	SOR - (1-1/4" O.D.) . . . . .	P-5236
(D)	MO/SOR - (1-3/16" O.D.) . . . . .	P-5240
(D)	MO/SOR - (1-1/2" O.D.) . . . . .	P-5243
(E)	K-Series/SORKZ - For tissue paper . . . . .	P-5218
(F)	Quickmaster 46 / 46DI . . . . .	P-7558
(G)	TOM / TOK . . . . .	P-5215

## SUCKER BAR SLIDES



GTO-46 (165 mm long - 2.5 mm holes red)	P-30752
GTO-46 (63 mm long - 2.5 mm holes red)	P-30753
WINDMILL 10x15 (261 mm long - 2.5 mm holes red)	P-30754
WINDMILL 10x15 (261 mm long - 3.8 mm holes yellow)	P-30755
WINDMILL 10x15 (261 mm long - 1.6 mm holes pink)	P-30756
WINDMILL 13x18 (327 mm long - 2.5 mm holes Red)	P-30797
WINDMILL 13x18 (327 mm long - 3.9mm holes Yellow)	P-30798
WINDMILL 13x18 (327 mm long - 1.6 mm holes Pink)	P-30799

## - BASE & DRIVE SECTION -

### FILTER CARTRIDGES



For TL6DV Pump . . . . .	P-1147HT6
For TL12DV Pump . . . . .	P-1147HT12
For TL61TV Pump . . . . .	P-1147HT61
For TL81TV Pump . . . . .	P-1147HT81

### FILTER SCREENS



Windmill Platens (23.5mm Metal Base O.D.) . . . . .	P-9410
GTO 46 & 52 (27.5mm Metal Base O.D.) . . . . .	P-9411
GTO 46/52, Windmill (38mm Metal Base O.D.) . . . . .	P-9412

# REPLACEMENT PARTS FOR HEIDELBERG BELTS, LIMIT SWITCHES



**SILENCER** - GTO 46/52, K-Series, SB-Series, & Windmill Platens

P-9413

## RIBBED V-BELTS



TOK - Drive motor (610mm) . . . . .	P-3780
TOK - Drive shaft (762mm) . . . . .	P-3783
GTO 46 - Drive motor (1168mm) . . . . .	P-3785
GTO 46/52 - Drive belt from variable speed pulley (900mm) . . . . .	P-3716
GTO 52 - Drive motor (1321mm) . . . . .	P-3788
GTO 52 Z/P, V/P - Drive motor (1016mm) . . . . .	P-3790
GTO 52 Z/P, V/P - Drive motor (1397mm) . . . . .	P-3791
Quickmaster 46DI - (long) . . . . .	P-3779
Quickmaster 46DI - (short) . . . . .	P-3778
MOFP, MOZP . . . . .	P-3777



## DRIVE BELTS - For GTO 46 / 52 Spray Powder Units

50 Cycle . . . . .	P-3706
60 Cycle . . . . .	P-3705

## COG BELTS



K Series - 50 cycle motors . . . . .	P-3885
K Series - 60 cycle motors . . . . .	P-3889
Windmill 10 X 15 - Main drive . . . . .	P-3893
Windmill 13 X 18 -Main drive. . . . .	P-3722

# REPLACEMENT PARTS FOR HEIDELBERG ELECTRICAL, CARBON BRUSHES, REPAIR KITS

## - ELECTRICAL -

### LIMIT SWITCHES



**A**



**B**



**C**



**D**

- |     |  |        |
|-----|--|--------|
| (A) | GTO 46/52, M/S Series, Speedmaster 72/102 . . . . .  | P-9836 |
| (B) | GTO 46/52, M/S Series, Speedmaster 72/102 . . . . .  | P-9837 |
| (C) | GTO 52, M-Series, Spdmst 102 (snap action) . . . . . | P-9838 |
| (C) | M-Series (slow action) . . . . .                     | P-9839 |
| (D) | GTO 46 / 52 - Located behind blower tubes. . . . .   | P-4074 |



#### ROLLER SNAP SWITCH - S Series, SM 102/72, M Series

(on OS outer delivery frame)

P-9805



#### Snap Switch - Quickmaster, TOK

P-4446

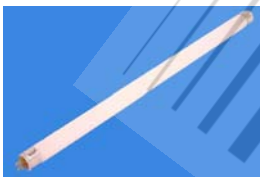

#### FLOURESCENT BULBS

8 Watt - GTO 46 / 52, TOK . . . . . P-9743

14 Watt - KORD 64, S-Series . . . . . P-9726

#### SLIP RING BRUSHES



K-Series (shown) . . . . . P-9428

S-Series . . . . . P-9438

S-Series . . . . . P-9439

Paired Collector Brush . . . . . P-9429



# REPLACEMENT PARTS FOR HEIDELBERG CAM FOLLOWERS

## CARBON BRUSHES

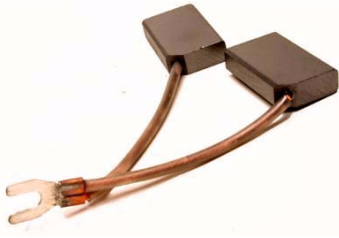

Speedmaster 102 . . . . .	P-9430
Carbon Brush (shown) . . . . .	P-9431
Carbon Brush . . . . .	P-9432
Speedmaster . . . . .	P-9433
Speedmaster 102Z . . . . .	P-9434
102+L, 102Z (Main motor) . . . . .	P-9435
Speedmaster 102V . . . . .	P-9436
102D . . . . .	P-9437
TOK/TOM (Motor) . . . . .	P-9440

## - HARDWARE EMERGENCY KITS -



COMPLETE MASTER KIT . . . . .	P-30397
NUT KIT - 43 pcs. . . . .	P-30392
SCREW KIT - 168 pcs. . . . .	P-30393
PIN KIT - 100 pcs. . . . .	P-30394
RING KIT - 47 pcs. . . . .	P-30395
WASHER KIT - 60 pcs. . . . .	P-30396

## CAM FOLLOWERS



<b>GTO 46</b>	
(A) Transfer & impression cylinder / gripper shaft. . . . .	P-3441
(B) Side lay shaft. . . . .	P-4368
<b>GTO 52</b>	
(A) Imp. cyl. & storage drum / gripper shaft. . . . .	P-3441
<b>K-SERIES</b>	
(C) Imp. cyl. shaft / sucker bar mechanism outer lever. . . . .	P-6870
<b>M-SERIES</b>	
(D) Transfer & imp. cyl. & storage drum / gripper shaft. . . . .	P-3416
(E) Reversing drum. . . . .	P-3443
(F) Register feed drum / gripper shaft. . . . .	P-3444
<b>SORZ / SORDZ / SORKZ / SORMZ / SORSZ</b>	
(G) Register feed drum / gripper shaft ..(cam facing cylinder O.S. & D.S.) . . . . .	P-3442
(H) Register feed drum / gripper shaft ..(cam facing side frames O.S. & D.S.) . . . . .	P-3445
(F) Impression cylinder & storage drum / gripper shaft. . . . .	P-3444
<b>SPEEDMASTER 72 / 102</b>	
(G) Register feed drum/ gripper shaft ..(cam facing cylinder O.S. & D.S.) . . . . .	P-3442
(H) Register feed drum / gripper shaft ..(cam facing side frames O.S. & D.S.) . . . . .	P-3445
(F) Transfer & impression cylinder / gripper shaft. . . . .	P-3444
(H) Transfer gripper. . . . .	P-3445
<b>SPEEDMASTER 74</b>	
(I) Delivery table. . . . .	P-3439
<b>SPEEDMASTER 102</b>	
(J) Gripper opening lever on delivery gripper bars. . . . .	P-6871
(G) On lever (OEM #71-010-110) / inking unit. . . . .	P-3442
<b>QUICKMASTER</b>	
(A) Impression cylinder / gripper shaft. . . . .	P-3441

HEIDELBERG IS A REGISTERED TRADEMARK OF HEIDELBERG-DRUCKMASCHINEN, AG



# REPLACEMENT PARTS FOR HEIDELBERG CYLINDER JACKETS, WASH UP BLADES

P-30851



• **STANDARD CYLINDER JACKETS**

<b>WINDMILL 10 X 15</b>	10 x 14-1/4	.....	P-30850
<b>WINDMILL 13 X 18</b>	12-7/8 x 17-3/4	.....	P-30858
<b>GTO 46</b>	15-1/2 x 18	.....	P-30851
<b>GTO 52</b>	16 x 20-3/8	.....	P-30852
<b>M-Series</b>	21-1/2 x 26	.....	P-30853
<b>KORD 62</b>	19-1/4 x 24-7/16	.....	P-30854
<b>KORD 64</b>	19-1/2 x 25-1/2	.....	P-30855
<b>KOR</b>	16-3/4 x 22-1/2	.....	P-30859
<b>KORA</b>	17 x 22-1/2	.....	P-30857
<b>KORS</b>	21-1/2 x 28-1/2	.....	P-30856

• **STAINLESS STEEL**

<b>Speedmaster 52</b>	15-1/4 x 20-7/8	.....	P-30867
-----------------------	-----------------	-------	---------

P-30861



• **REFINED CYLINDER JACKETS**

<b>GTO 46</b>	15-1/2 x 18	.....	P-30860
<b>GTO 52</b>	16 x 20-3/8	.....	P-30861
<b>MO</b>	21-3/4 x 26	.....	P-30862
<b>Speedmaster 72</b>	21-1/16 x 29-1/4	.....	P-30863
<b>Speedmaster 102</b>	27-15/16 x 40-3/4	.....	P-30864

• **DIE CUTTING**

<b>KSBA</b>	21-1/2 x 28-1/2	.....	P-30865
<b>SBB/SBBS</b>	21-1/4 x 32-1/4	.....	P-30866
<b>KSBAZ</b>	18-5/8 x 22-1/2	.....	P-30869
<b>S-Series</b>	22-1/4 x 28-3/8	.....	P-30887
<b>SBG</b>	24 x 30-1/4	.....	P-30890

**WASH -UP BLADES**



**P-30209 (Pictured)  
for WINDMILL 10 x 15**

<b>GTO 46</b>	19-3/4 x 2-3/8	.....	5 holes	.....	P-5075
<b>GTO 52</b>	22-1/16 x 2-1/4	.....	6 holes	.....	P-30203
<b>GTO NUMBERING 46</b>	17-1/2 x 1-5/8	.....	3 holes	.....	P-30231
<b>GTO NUMBERING 52</b>	20-1/4 x 1-1/2	.....	3 holes	.....	P-30784
<b>KOR, KORA</b>	23-9/16 x 2	.....	10 holes	.....	P-30218
<b>KORD 62</b>	25-5/8 x 2	.....	12 holes (3 sizes)	.....	P-30268
<b>KORD 64</b>	27-3/16 x 2	.....	12 holes	.....	P-30222
<b>KORS</b>	29-15/16 x 2	.....	12 holes	.....	P-30230
<b>KSBA</b>	22-3/8 x 1-3/4	.....	8 holes	.....	P-30264
<b>MO, (SORK gray machine)</b>	27-15/16 x 2-3/8	..	8 holes	.....	P-30269
<b>MO, (SORK black machine)</b>	28-7/16 x 2	.....	12 holes (2 sizes)	.....	P-30261
<b>MO</b>	27-1/4 x 2-3/8	.....	7 holes (2 slots)	.....	P-30267

----- CONTINUED ON NEXT PAGE -----

# REPLACEMENT PARTS FOR HEIDELBERG

## WASH UP BLADES, INK FOUNTAIN BLADES

---

### WASH UP BLADES

----- CONTINUED FROM PREVIOUS PAGE -----

<b>Quickmaster 46 &amp; 46DI</b>	14-7/8 x 1-47/64 . . . . .	5 slots (plastic) . . . . .	P-30279
<b>RZO ROTASPEED</b>	41-3/8 x 2-3/8 . . . . .	11 holes (2 slots) . . . . .	P-30275
<b>SORD</b>	37-3/4 X 2 . . . . .	14 holes . . . . .	P-30272
<b>SORD</b>	37-3/4 X 2-3/8 . . . . .	10 holes . . . . .	P-30273
<b>SORD, SORDZ</b>	36-7/16 X 1-9/16 . . . . .	10 holes (6 slots) . . . . .	P-31301
<b>SORMZ, Speedmaster 72</b>	31-1/8 x 2-3/8 . . . . .	11 holes . . . . .	P-30271
<b>SORMZ POST DRUPA</b>	29-11/16 x 1-5/8 . . . . .	9 holes (2 slots) . . . . .	P-30270
<b>SORZ</b>	35-1/16 x 2 . . . . .	10 holes . . . . .	P-30286
<b>Speedmaster</b>	41 X 2-3/8 . . . . .	12 holes . . . . .	P-30274
<b>Speedmaster</b>	41-7/16 X 1-5/8 . . . . .	11 holes (2 slots) . . . . .	P-30276
<b>Speedmaster 52</b>	23-13/16 x 1-13/16 . . . . .	7 holes . . . . .	P-30791
<b>Speedmaster 102</b>	43 x 2-3/8 . . . . .	11 holes (2 slots) . . . . .	P-30277
<b>Speedmaster 74</b>	32-1/2 x 2-1/4 . . . . .	9 holes (2 slots) . . . . .	P-30235
<b>TOK</b>	11-1/8 x 1-11/16 . . . . .	4 holes (plastic) . . . . .	P-30242
<b>WINDMILL 10 X 15</b>	14-15/16 x 2 . . . . .	5 slots . . . . .	P-30209
<b>WINDMILL 13 X 18</b>	18-9/16 x 2-1/16 . . . . .	6 holes . . . . .	P-30243

### INK FOUNTAIN BLADES



<b>GTO 46</b>	45.3cm x 8.4cm . . . . .	HE-46095
<b>GTO 52</b>	51.3cm x 9.4cm . . . . .	HE-52095
<b>KOR</b>	58cm x 10.1cm . . . . .	HE-KØR095
<b>KORD 64</b>	67.1cm x 10.1cm . . . . .	HE-KØRD095
<b>KORS</b>	74.2cm x 10.1cm . . . . .	HE-KØRS095
<b>M-Series</b>	66.2cm x 12.9cm . . . . .	HE-MØØ95
<b>QUICKMASTER</b>	33.6cm x 7.1cm . . . . .	HE-46079QM
<b>SORDZ</b>	90.1cm x 11.7cm . . . . .	HE-SØRDZ095
<b>SORM, Speedmaster 72</b>	73cm x 11.7cm . . . . .	HE-SØRM095
<b>SORMZ</b>	73.1cm x 17.5cm . . . . .	HE-SØRMZ095
<b>SORZ</b>	83.1cm x 11.8cm . . . . .	HE-SØRZ095
<b>SORKZ</b>	66cm x 11.8cm . . . . .	HE-SØRKZ095
<b>SORSZ, Speedmaster 102</b>	103.1cm x 17.5cm . . . . .	HE-SØRSZ095
<b>TOK, TOM</b>	27.6cm x 7.1cm . . . . .	HE-TØØ95
<b>WINDMILL 10 X 15</b>	37.6cm x 10.1cm . . . . .	HE-WI095-15
<b>WINDMILL 13 X 18</b>	48cm x 10.1cm . . . . .	HE-WI095-18

# REPLACEMENT PARTS FOR HEIDELBERG ROLLER KITS

**HERE ARE SOME EXAMPLES OF ALL THE INK AND WATER ROLLER KITS WE SELL.**  
 FOR MORE INFORMATION ON OTHER ROLLER KITS  
 CALL 1-800-444-4338 / E-Mail:prpsales@printersrepairparts.com

## GTO 46 / 52 SERIES

### GTO 46

INK ROLLER KIT . . . . . P-30457

Consists of:

- (6) Blue Distributor / Ductor . . . . . P-46H10B
- (1) Red Form . . . . . P-46H10R
- (1) White Form . . . . . P-46H10W
- (1) Yellow Form. . . . . P-46H10Y

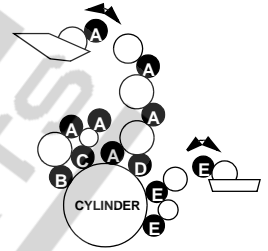

## K-SERIES

### KORD 62

INK ROLLER KIT . . . . . P-31656

Consists of:

- (2) Blue Form / Distributor . . . . . P-30916
- (3) Red Form / Distributor / Ductor . . . . . P-30918
- (2) White Form / Distributor / Ductor . . . . . P-30917
- (2) Brown Form / Distributor / Ductor . . . . . P-30919

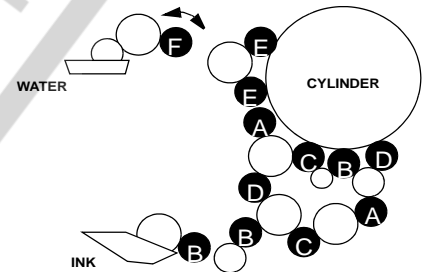

## M-SERIES

### MO

INK ROLLER KIT (conventional & Alcolor) . . . P-31839

Consists of:

- (2) Blue Form / Distributor . . . . . P-31840
- (4) Red Form / Distributor / Ductor . . . . . P-31841
- (2) White Form / Distributor . . . . . P-31842
- (2) Yellow Form / Distributor . . . . . P-31843

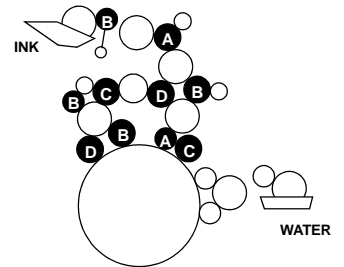

## QUICKMASTER 46 & 46DI SERIES

### QUICKMASTER 46 (1ST. UNIT)

INK ROLLER KIT . . . . . P-31735

Consists of:

- (1) Yellow 1st. Ink Form . . . . . P-34H10
- (1) Blue 2nd. Ink Form. . . . . P-34H11
- (1) Black 3rd. Ink Form . . . . . P-34H13
- (1) Black Ink Transfer Roll #1 . . . . . P-34H20
- (1) Black Ink Transfer Roll #2 . . . . . P-34H21
- (1) Black Ink Transfer Roll #3 . . . . . P-34H22
- (1) Black Ductor . . . . . P-34H30

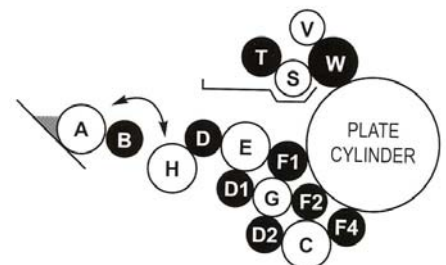

# REPLACEMENT PARTS FOR HEIDELBERG BLANKETS



**P-30551 Pictured**

**• BLANKETS**

GTO 46. . . . .	17-5/16" x 18-1/8" . . . .	P-30551
GTO 52. . . . .	17-1/2" x 20-1/2" . . . .	P-30552
KOR . . . . .	18-1/2" x 22-1/2" . . . .	P-30553
KOR . . . . .	18-1/2" x 23-5/8" . . . .	P-30554
KORA . . . . .	20-1/4" x 23-5/8" . . . .	P-30555
KORD 62 . . . . .	20-1/4" X 24-5/8" . . . .	P-30510
KORD 64 . . . . .	20-2/5" x 26-1/2" . . . .	P-30557
KORS. . . . .	23" x 29-3/8" . . . . .	P-30562
MO . . . . .	22-1/4" x 26-1/2" . . . .	P-30558
QUICKMASTER . . . . .	21-7/8 x 13-1/4" . . . .	P-30790
RZ . . . . .	28" x 40" . . . . .	P-31255
SOR . . . . .	27-1/8" x 33-1/2" . . . .	P-30563
SORD. . . . .	28-1/8" x 36-1/4" . . . .	P-30564
SORM. . . . .	23-3/4" x 28-3/4" . . . .	P-30560
SORM. . . . .	23-3/4" x 29-5/8" . . . .	P-30561
SORKZ . . . . .	22-1/4" x 26-7/8" . . . .	P-30559
SPEEDMASTER . . . . .	31-1/8" x 41-3/8" . . . .	P-30566
TOK . . . . .	10" x 16" . . . . .	P-30550

**• UNDER BLANKETS**

GTO 46. . . . .	15-3/4" x 17-7/8" . . . .	P-30570
GTO 52. . . . .	15-15/16" x 20-9/32" . . . .	P-30571
KOR . . . . .	17-1/8" x 23-5/8" . . . .	P-30572
KORA . . . . .	18-7/8" x 23-5/8" . . . .	P-30573
KORD 62 . . . . .	18-7/8" x 24-5/8" . . . .	P-30574
KORD 64 . . . . .	19-1/2" x 26-1/2" . . . .	P-30575
KORS. . . . .	21-7/8" x 28-7/8" . . . .	P-30577
SOR . . . . .	25-3/4" x 32-7/8" . . . .	P-30578
SORD. . . . .	26-3/4" x 35-3/4" . . . .	P-30579
SORKZ . . . . .	20-7/8" x 26-1/4" . . . .	P-30576

HEIDELBERG IS A REGISTERED TRADEMARK OF HEIDELBERG-DRUCKMASCHINEN, AG

# REPLACEMENT PARTS FOR HEIDELBERG TOOLS

## Open End Wrench



22 mm, 19 mm . . . . .	P-30800
17 mm, 13 mm . . . . .	P-30801
10 mm, 8 mm . . . . .	P-30802
13 mm, 10 mm . . . . .	P-5889
17 mm, 14 mm . . . . .	P-5994
27 mm, 24 mm . . . . .	P-5998

## Allen Key



6 mm . . . . .	P-5078
5 mm . . . . .	P-5079
4 mm . . . . .	P-5080
3 mm . . . . .	P-5041

## Slotted Screwdriver



P-5862

## Pin Wrench



4 mm, 6 mm . . . . .	P-5875
3 mm . . . . .	P-5876
11 mm . . . . .	P-5992

## Pressure ADJ Spanner Wrench for Speedmaster, M Series and S Series



P-5877

## T-Handle Socket Wrench



13 mm . . . . .	P-5878
17 mm . . . . .	p-5882

## Box Spanner Wrench



10 mm . . . . .	P-5884
17 mm . . . . .	P-5886
19 mm . . . . .	P-5887

## Wrench for Dist. Cyl. - Speedmaster and S Series



P-5891

## Small Bearing Puller



P-5896

REPLACEMENT PARTS FOR HEIDELBERG  
**NOTES**

---

